

Mini DisplayPort Interoperability Test Adapter

User Manual



WILDER
TECHNOLOGIES

It's all about integrity

Table of Contents

Introduction.....	3
Product Inspection	5
The Mini DisplayPort Test Adapter Care and Handling Precautions.....	6
General Test Adapter, Cable, and Connector.....	8
Handling and Storage	8
Visual Inspection	8
Cleaning.....	8
Making Connections.....	8
Electrostatic Discharge Information.....	9
User Model.....	10
Calibration	13
SOLT.....	14
1X-THRU	15
Calibration Through De-Embedding.....	16
Mechanical and Environmental Specifications.....	17
Electrical Specifications	20
Wilder Technologies, LLC – Limited Warranty	32
Wilder Technologies, LLC – Terms & Conditions of Sale	33
Compliance with Environmental Legislation	34
WEEE Compliance Statement.....	Error! Bookmark not defined.
Glossary of Terms	35
Index	36

Introduction

This user's guide documents the Mini DisplayPort Interoperability Test Adapter (mDPI-TPA) and Calibration Module. The two test adapter types, shown in Figures 1 and 2, test Mini DisplayPort Interface (mDP) cables and devices against the VESA DisplayPort™ PHY Compliance Test Specification and the VESA DisplayPort™ Interoperability Guideline. The Interoperability allows access to dual mode (supporting HDMI) and tethered cable operation. See the Aux Control User Manual, 910-0015-000, for more information. The Calibration Module, shown on Page 13, is used to zero-out test adapter attributes (using SOLT, with either the 1X-THRU or the 2X-THRU).

The TPA-P and TPA-R test adapter assemblies allow easy access, via SMA connections, to measure or inject Main Link and Auxiliary signals. These test adapters also provide access to Hot Plug Detect, DP Power, two Grounds, Config1, and Config2 via a 6-position low-speed connector.

NOTE: To avoid damaging the cables, use the handling techniques described in the Care and Handling section before making any connections or configuring a test setup.

Always use a static-safe workstation when performing tests, as explained in the "Electrostatic Discharge Information" section.

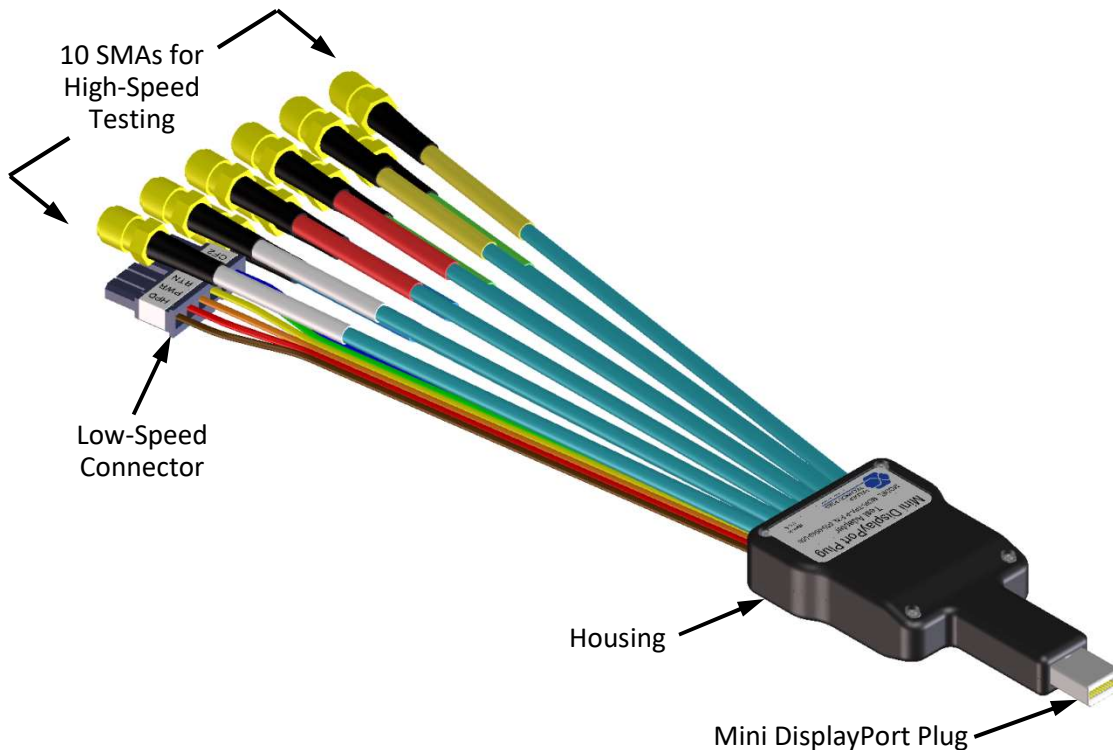

Figure 1. The Mini DisplayPort Test Adapter (Plug)

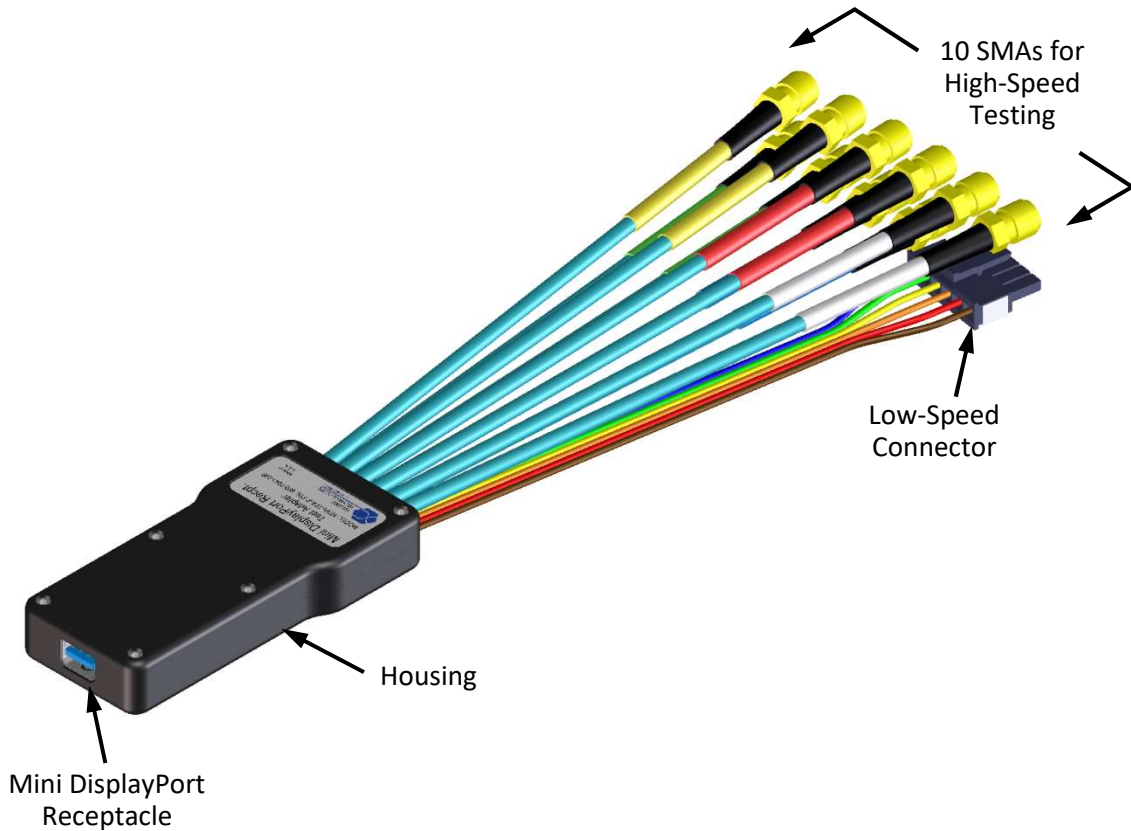

Figure 2. The Mini DisplayPort Test Adapter (Receptacle)

NOTE: The metal shell of both the plug (mDPI-TPA-P) and receptacle (mDPI-TPA-R) connectors are configured at the factory to tie high-speed ground to chassis ground.

The low-speed 6-position receptacle connector is keyed and latching (Molex part number 43645-0600). The mating plug connector housing and contact pins for 26-30awg wire are provided with each mDPI-TPA assembly (Molex part numbers 43640-0601 for the 6-position housing and 43031-0011 for the 26-30awg pin contact). Replacement plug parts can be purchased through Molex distributors.

Product Inspection

Upon receiving the mDPI-TPA from Wilder Technologies, perform the following product inspection:

- Inspect the outer shipping container, foam-lined instrument case, and product for damage. Retain the outer cardboard shipping container until the contents of the shipment have been inspected for completeness and the product has been checked mechanically and electrically. Use the foam-lined instrument-case for secure storage of the Wilder Technologies Mini DisplayPort Test Adapter when not in use.
- Locate the shipping list and verify that all items ordered were received.
- In the unlikely event that the product is defective or incomplete, the “Limited Warranty” section discusses how to contact Wilder Technologies for technical assistance and/or how to package the product for return.

The Mini DisplayPort Test Adapter Care and Handling Precautions

The Mini DisplayPort Test Adapter requires careful handling to avoid damage. Improper handling techniques, or using too small a cable bend radius, can damage the coaxial cable connections within the adapter housing or the cables themselves. This can occur at any point along the cable. To achieve optimum performance and to prolong the mDPI-TPA's life, observe the following handling precautions:

- **CAUTION 1: Avoid Torque Forces (Twisting)**
While individual coaxial cables within the test adapter have some rotational freedom, twisting the mDPI-TPA as a unit, with one end held stationary, in excess of +/- 90° may damage or severely degrade performance. Adherence to Caution 5 (below) helps to avoid exceeding twist limits.
- **CAUTION 2: Avoid Sharp Cable Bends**
Never bend coaxial cables into a radius of 26 mm (1 -inch) or less. Never bend cables greater than 90°. Single or multiple cable bends must be kept within this limit. Bending the mDPI-TPA cables less than a 26mm (1-Inch) radius will permanently damage or severely degrade test adapter performance.
- **CAUTION 3: Avoid Cable Tension (Pull Forces)**
Never apply tension (pull forces) to an individual coaxial cable that is greater than 2.3 kg (5 lbs.). To avoid applying tension, always place accessories and equipment on a surface that allows adjustment to eliminate tension on the mDPI-TPA and cables. Use adjustable elevation stands or apparatus to accurately place and support the mDPI-TPA.
- **CAUTION 4: Connect the mDPI-TPA First**
To prevent twisting, bending, or applying tension to the coaxial cables when connecting a mDPI-TPA, always attach the mDPI-TPA to the device under test (DUT) or cable under test before attaching any SMA connectors. Carefully align the Mini DisplayPort connectors and then gently push the connectors together until fully seated.

If the mDPI-TPA must be turned or twisted to make connection to the DUT, avoid using the mDPI-TPA housing alone to make this occur. Try to distribute the torque forces along the length of the test setup and cabling. If this is not possible, it is recommended to first loosen or disconnect the SMA connections at the mDPI-TPA, make the connection to the DUT and then re-tighten or attach the test equipment leads.

NOTE: Only grip the test adapter housing when inserting or extracting the mDPI-TPA to or from the DUT. Pulling directly on the mDPI-TPA cables or using them to insert the mDPI-TPA may cause damage.

- **CAUTION 5: Carefully Make SMA Connections**

To connect the mDPI-TPA SMA connectors, follow these steps:

1. Hold the cable stationary by grasping the cable at the black heat-shrink section near the SMA connector.
2. Insert the mating SMA barrel and hand-tighten the free-spinning SMA nut onto the connector while avoiding pulling, bending, or twisting the mDPI-TPA coaxial cable.
3. The mDPI-TPA SMA connectors have flats that accept an open-end 1/4-inch or 6.5mm wrench. When attaching instrument cables to the mDPI-TPA, it is recommended that the mDPI-TPA SMA connectors be mechanically held and the test leads be tightened to the equipment manufacturer's torque recommendations, normally 5 in-lbs, using a 5/16-inch open-end wrench.

If the test set-up requires repositioning, first loosen or disconnect the SMA connections to avoid twisting, bending, or tension.

NOTE: A drop in signal amplitude by half or 6dB during the testing of a lane may indicate that a cable has been mechanically pulled free of coaxial cable connections internal to the assembly. This could be determined by checking if the cable has any lateral play relative to the TPA. This would only occur when the TPA has exceeded the pull force as specified within the mechanical specification. If the cable cannot be re-seated, the test adapter will need to be sent back to the factory for service.

- **CAUTION 6: Independently Support Instrument Cables or Accessories**

Excessive weight from instrument cables and/or accessories connected to the mDPI-TPA can cause damage or affect the test adapter performance. Be sure to provide appropriate means to support and stabilize all test set-up components.

General Test Adapter, Cable, and Connector

Observing simple precautions can ensure accurate and reliable measurements.

Handling and Storage

Before each use of the mDPI-TPA, ensure that all connectors are clean. Handle all cables carefully and store the mDPI-TPA in the foam-lined instrument case when not in use, if possible. Do not set connectors contact end down. Install the SMA protective end caps when the mDPI-TPA is not in use.

Visual Inspection

Be sure to inspect all cables carefully before making a connection. Inspect all cables for metal particles, scratches, deformed threads, dents, or bent, broken, or misaligned center conductors. Do not use damaged cables.

Cleaning

If necessary, clean the connectors using low-pressure (less than 60 PSI) compressed air or nitrogen with an effective oil-vapor filter and condensation trap. Clean the cable threads, if necessary, using a lint-free swab or cleaning cloth moistened with isopropyl alcohol. Always completely dry a connector before use. Do not use abrasives to clean the connectors. Re-inspect connectors, making sure no particles or residue remains.

Making Connections

Before making any connections, review the “Care and Handling Precautions” section. Follow these guidelines when making connections:

- Align cables carefully
- Make preliminary connection lightly
- To tighten, turn connector nut only
- Do not apply bending force to cable
- Do not over-tighten preliminary connections
- Do not twist or screw-in cables
- Use an appropriately sized torque wrench (depends on SMA gender), and do not tighten past the “break” point of the torque wrench (normally set to 5 in-lbs.)

Electrostatic Discharge Information

Protection against electrostatic discharge (ESD) is essential while connecting, inspecting, or cleaning the mDPI-TPA test adapter and connectors attached to a static-sensitive circuit (such as those found in test sets).

Electrostatic discharge can damage or destroy electronic components. Be sure to perform all work on electronic assemblies at a static-safe work station, using two types of ESD protection:

- Conductive table-mat and wrist-strap combination
- Conductive floor-mat and heel-strap combination

When used together, both of these types provide a significant level of ESD protection. Used alone, the table-mat and wrist-strap combination provide adequate ESD protection. To ensure user safety, the static-safe accessories must provide at least 1 M Ω of isolation from ground. Acceptable ESD accessories may be purchased from a local supplier.

WARNING: These techniques for a static-safe work station should not be used when working on circuitry with a voltage potential greater than 500 volts.

User Model

The Mini DisplayPort TPA supports all testing of the DisplayPort PHY CTS. It is capable of performing well beyond the scope of measurements contained in the PHY CTS, limited only by the specifications, environmental, care and handling as stated in this document.

The following examples are suggestions for possible testing setups.

In this first example, a Mini DisplayPort plug TPA acts as a sink:

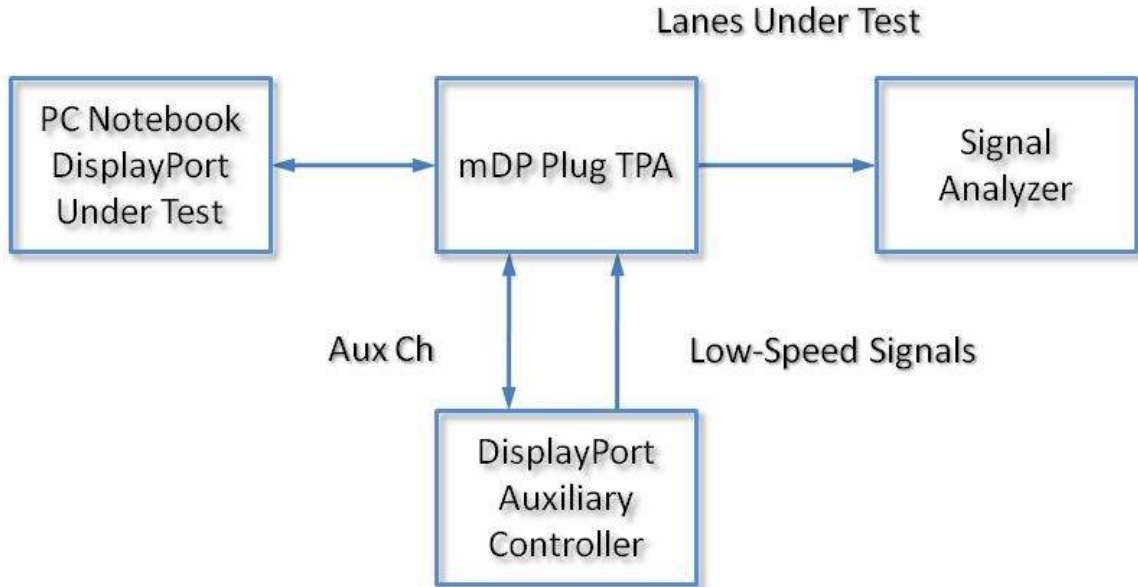

In the second example, the Mini DisplayPort plug acts as a source:

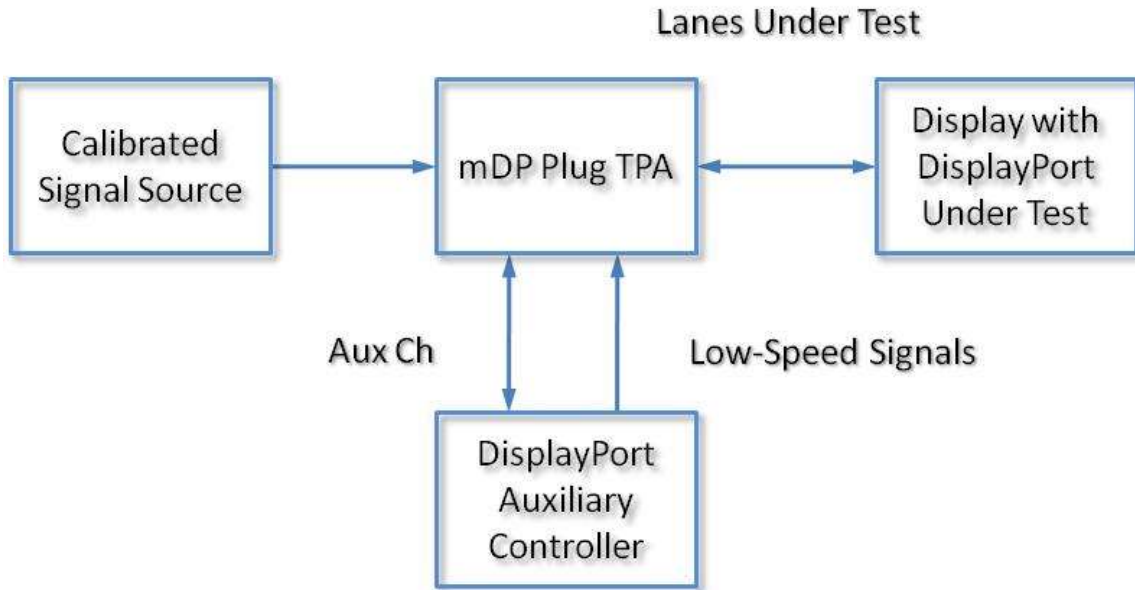

The third example shows two Mini DisplayPort receptacle TPAs acting as source and sink:

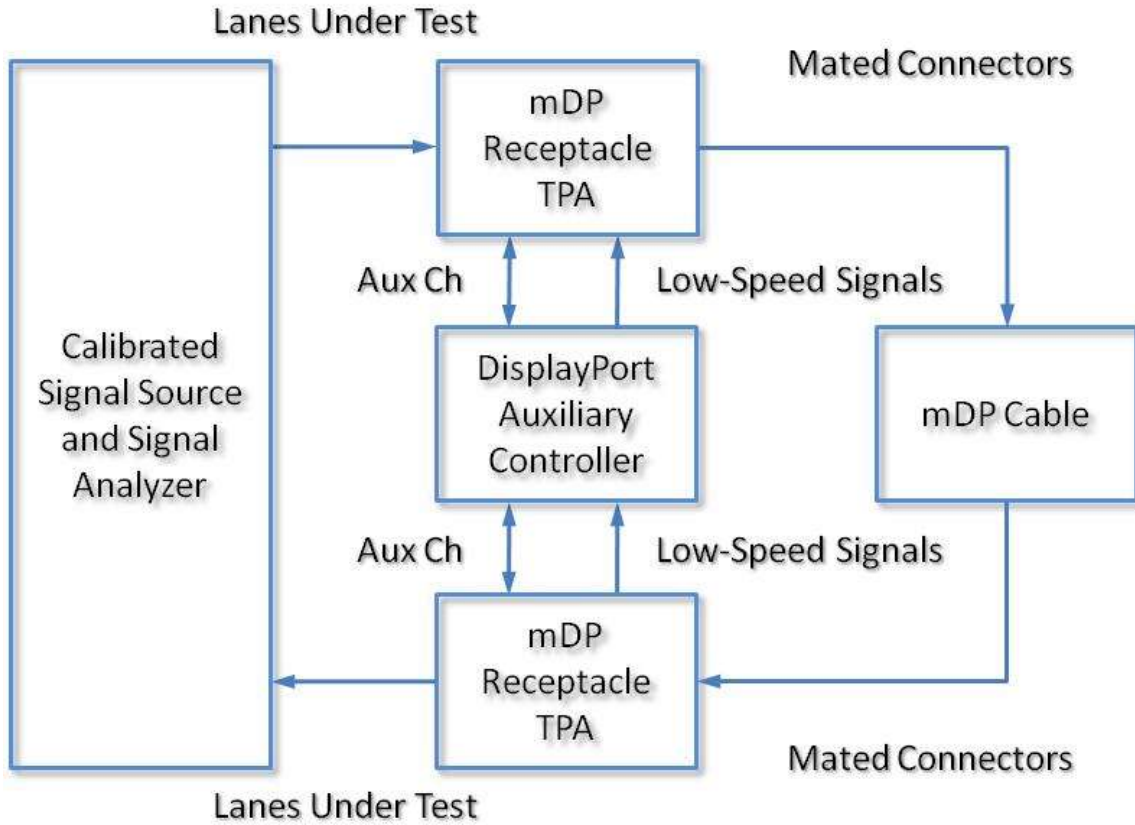

Calibration

The Mini DisplayPort Plug and Receptacle Test Adapters are passive components. Therefore, calibration for the errors generated must occur within the test instrumentation that drives the sink or looks at the response of the source.

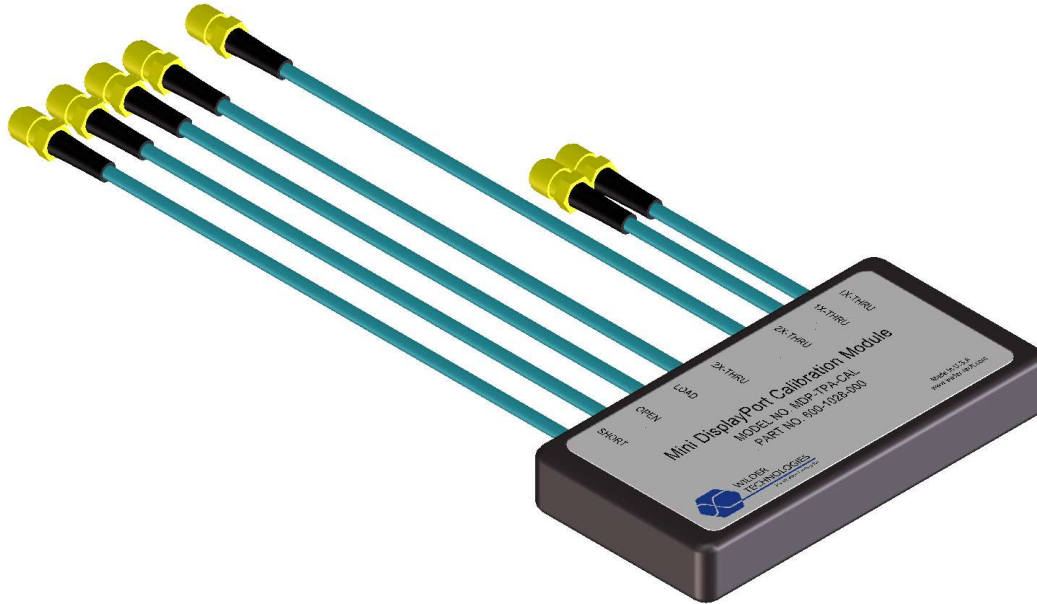

Figure 3. Calibration module (mDP-TPA-C) showing standard 6-inch cable on SOLT and 3-inch cables connected to the 1X-THRU

SOLT

SHORT, OPEN, LOAD, and 2X-THRU (SOLT) are calibration standards used to compensate for errors associated with the TPA when used for Jitter measurement, TDR, TDT, and VNA testing. SOLT represents the same electrical length and losses as the TPA through the Mini DisplayPort connector pad, and enables the test engineer to compensate for the following six repeatable, systematic errors that occur when moving the reference plane:

- Signal leakage effects: *Directivity errors*
- Signal leakage effects: *Crosstalk errors*
- Reflection effects: *Source Impedance Mismatching errors*
- Reflection effects: *Load Impedance Mismatching errors*
- Bandwidth effects: *Receiver Transmission in Test Equipment errors*
- Bandwidth effects: *Receiver Reflection-tracking in Test Equipment errors*

These errors need to be corrected on each port. Refer to the Instrument Manual for instructions on the instrument's specific calibration process.

NOTE: The reference plane is the boundary, both physically and electrically, between the calibrated and uncalibrated portions of the circuit. Everything outside the reference plane is considered part of the DUT. Any instrument that does not use calibration defines the DUT as the total of externally connected components. If the mDP-TPA-C is not used, the entire Mini DisplayPort TPA and the 6-inch cables, as well as cables connecting the 6-inch cables to the test instrument, would be a part of the DUT.

Non-repeatable errors, such as drift or random errors can be reduced but not corrected. Drift errors aggregate over time or with environmental changes such as temperature shift. To eliminate drift errors, perform another calibration.

A random error cannot be corrected through calibration since the error occurred randomly. Random errors are typically associated with either test instrument noise or test repeatability problems. Reduce test instrument noise by increasing source power, lowering the IF bandwidth, or averaging results over multiple sweeps. Reduce test repeatability problems through the use of a torque wrench or, again, by averaging over multiple sweeps.

1X-THRU

The 1X-THRU is a calibration feature used to calibrate time domain instrumentation (for example, pre-emphasized pulse generators or AWGs, arbitrary waveform generators). 1X-THRU calibration compensates two error sources – cable losses and group delay:

- **Cable Losses** – Cable losses associated with the Mini DisplayPort plug TPA, and its respective cabling that’s connected to the test source, consist of skin loss and, to a lesser extent, dielectric loss. Pre-emphasis or de-emphasis is used at the signal source to correct for these cable losses. Pre-emphasis is a boost of the signal level just after an edge transition; de-emphasis is a reduction in the low-speed amplitude of the signal source. Typically, on a de-emphasized signal the levels have to be reset to attain the same output levels. Resultant signals from either pre-emphasis or de-emphasis are identical relative to the DUT.

For the purposes of this discussion, pre-emphasis will be used. To set the pre-emphasis, first determine the amount of signal boost by connecting the signal source, via the 1X-THRU and the respective cable used to connect the DUT to the source to a high-speed oscilloscope or a jitter measurement device. Trigger the oscilloscope or jitter measurement device using a trigger from the source. The trigger, a single event, indicates the start of the signal being sent to the DUT. Adjust pre-emphasis to maximize the eye opening.

- **Group Delay** – Group delay is the second error source for 1X-THRU calibration. When the DUT generates an output signal, it can be used to measure delay. To create a baseline delay measurement, connect the output signal cable to the input signal cable and the 1X-THRU. To determine corrected DUT delay, subtract this baseline measurement from the DUT delay measurements.

Calibration Through De-Embedding

The Mini DisplayPort Plug and Receptacle Test Adapters are passive components. Therefore, calibration compensating for the losses must occur within the test instrumentation that drives the sink or looks at the response of the source.

The Mini DisplayPort Test Adapters have Touchstone S4P files for de-embedding the electrical length and losses within the TPA up to the Mini DisplayPort connector interface pads. (Contact Wilder Technologies, support@wilder-tech.com, to obtain a copy of the S4P files.) The Touchstone S4P files enable the test engineer to compensate for the last four of the following six repeatable, systematic errors that occur when moving the reference plane:

- Signal leakage effects: *Directivity errors*
- Signal leakage effects: *Crosstalk errors*
- Reflection effects: *Source Impedance Mismatching errors*
- Reflection effects: *Load Impedance Mismatching errors*
- Bandwidth effects: *Receiver Transmission in Test Equipment errors*
- Bandwidth effects: *Receiver Reflection-tracking in Test Equipment errors*

These errors are corrected on each port. Refer to the Instrument Manual for instructions on the instrument's specific de-embedding process.

NOTE: The reference plane is the boundary, both physically and electrically, between the calibrated and uncalibrated portions of the circuit. Everything outside the reference plane is considered part of the DUT. Any instrument that does not use calibration or de-embedding of the test fixture defines the DUT as the total of externally connected components. If the de-embedding file is not used, all of the mDPI-TPA and associated coaxial cables, as well as cables connecting the TPA assembly to the test instrument, would be a part of the DUT.

Non-repeatable errors, such as drift or random errors, can be reduced but not corrected. Drift errors aggregate over time or with environmental changes such as temperature shift. To eliminate drift errors, perform an instrumentation-level calibration.

A random error cannot be corrected through calibration since the error occurred randomly. Random errors are typically associated with either test instrument noise or test repeatability problems. Reduce test instrument noise by increasing source power, lowering the IF bandwidth, or averaging results over multiple sweeps. Reduce test repeatability problems through the use of a torque wrench or, again, by averaging over multiple sweeps.

Mechanical and Environmental Specifications

NOTE: All specifications in this manual are subject to change.

Table 1. General Specifications

ITEM	DESCRIPTION
Usage Environment	Controlled indoor environment
Test Adapter Length (w/standard cables)	196.9 mm +/- 2 mm (7.75 inches +/- .08 inches) (Characteristic)
Operating Temperature	0°C to +55°C (32°F to +131°F) (Characteristic)
Storage Temperature	-40°C to +70°C (-40°F to +158°F) (Characteristic)

mDPI-TPA Cable Pinout

The Mini DisplayPort Interoperability Test Adapters provide ten SMA connectors (Main Link and Auxiliary signals) and one low-speed connector. Labels clearly mark each cable or connector. The following figure refers to pin-description tables for each of the two connector types.

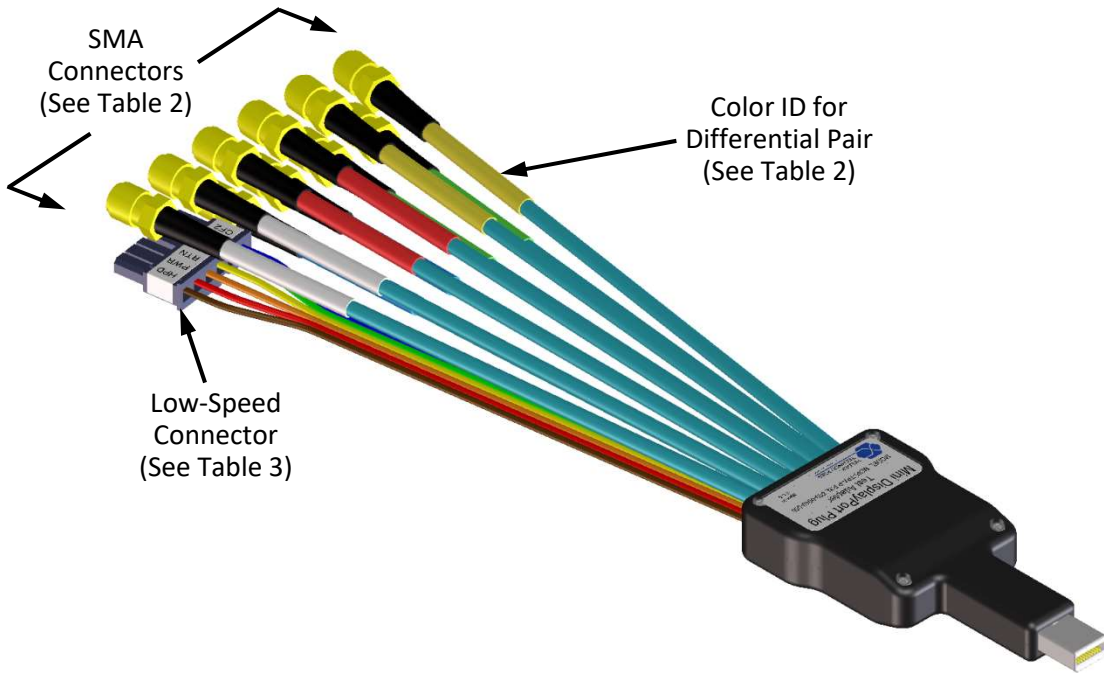

Figure 4. Cable Connectors (mDPI-TPA-P shown)

Table 2. SMA Cable Connectors (High-Speed)

LABEL	COLOR ID FOR DIFFERENTIAL PAIR	DESCRIPTION
T0_P/R3_N	White	Differential Data Lane 0+ for Source, Lane 3- for Sink
T0_N/R3_P	White	Differential Data Lane 0- for Source, Lane 3+ for Sink
T1_P/R2_N	Red	Differential Data Lane 1+ for Source, Lane 2- for Sink
T1_N/R2_P	Red	Differential Data Lane 1- for Source, Lane 2+ for Sink
T2_P/R1_N	Yellow	Differential Data Lane 2+ for Source, Lane 1- for Sink
T2_N/R1_P	Yellow	Differential Data Lane 2- for Source, Lane 1+ for Sink
T3_P/R0_N	Blue	Differential Data Lane 3+ for Source, Lane 0- for Sink
T3_N/R0_P	Blue	Differential Data Lane 3- for Source, Lane 0+ for Sink
AUX_P	Green	Differential Auxiliary Channel Positive (+)
AUX_N	Green	Differential Auxiliary Channel Negative (-)

Table 3. mDPI-TPA 6-position Cable Connector “P2” (Low-Speed)

LABEL	PIN NO.	COLOR ID FOR TPA	DESCRIPTION
HPD	Pin 1	Brown	Hot Plug Detect
PWR	Pin 2	Red	DP_PWR
GND	Pin 3	Orange	Ground
GND	Pin 4	Yellow	Ground
CF1	Pin 5	Green	Config1
CF2	Pin 6	Blue	Config2

Table 4. Mini DisplayPort Plug and Receptacle Pin Assignments

Pin Description	Connector Pin Number	Destination Number (Source/Sink)	Color Identification (Plug/Receptacle)
Ground	1	Ground	N/A
Hot Plug Detect	2	P2 Pin 1	Brown Insulation
ML Lane 0 (p) – Source ML Lane 3 (n) – Sink	3	T0_P/R3_N	White Label
Config1	4	P2 Pin 5	Green Insulation
ML Lane 0 (n) – Source ML Lane 3 (p) – Sink	5	T0_N/R3_P	White Label
Config2	6	P2 Pin 6	Blue Insulation
Ground	7	Ground	N/A
Ground	8	Ground	N/A
ML Lane 1 (p) – Source ML Lane 2 (n) – Sink	9	T1_P/R2_N	Red Label
ML Lane 3 (p) – Source ML Lane 0 (n) – Sink	10	T3_P/R0_N	Blue Label
ML Lane 1 (n) – Source ML Lane 2 (p) – Sink	11	T1_N/R2_P	Red Label
ML Lane 3 (n) – Source ML Lane 0 (p) – Sink	12	T3_N/R0_P	Blue Label
Ground	13	Ground	N/A
Ground	14	Ground	N/A
ML Lane 2 (p) – Source ML Lane 1 (n) – Sink	15	T2_P/R1_N	Yellow Label
AUX CH (p)	16	AUX_P	Green Label
ML Lane 2 (n) – Source ML Lane 1 (p) – Sink	17	T2_N/R1_P	Yellow Label
AUX CH (n)	18	AUX_N	Green Label
Ground	19	Ground	N/A
DP_PWR	20	P2 Pin 2	Red Insulation
Ground	1,7,8,13,14,19	P2 Pin 3	Orange Insulation
Ground	1,7,8,13,14,19	P2 Pin 4	Yellow Insulation

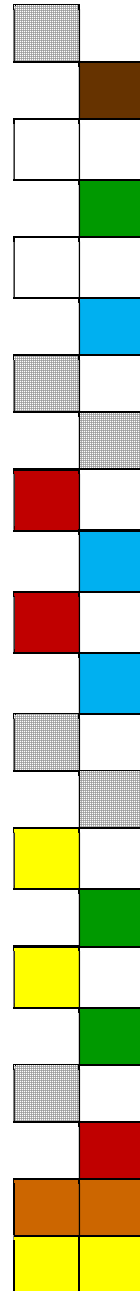

Electrical Specifications

NOTE: All specifications in this manual are subject to change.

Table 5. Electrical Specifications

SPECIFICATION	MINIMUM	TYPICAL	MAXIMUM	NOTES
Insertion Loss (GHz), at -3 dB	10	15		2X-THRU with six-inch cables
Return Loss (GHz), at -20 dB	7	18		2X-THRU with six-inch cables
Insertion Loss (GHz), at -3 dB		24.7		1X-THRU with three-inch cables
Return Loss (GHz), at -20 dB		9.7		1X-THRU with three-inch cables
VSWR, at 7 GHz	1.21:1			2X-THRU with six-inch cables
Differential Impedance (ohms), at 100ps Rise Time	95		105	All lanes and Aux CH, Receptacle and Plug, excluding Mini DisplayPort connector
Impedance (ohms), at 100ps Rise Time	47.5		52.5	All lanes and Aux CH, Receptacle and Plug, excluding Mini DisplayPort connector
Impedance (ohms), at 100ps Rise Time	47.5		52.5	SHORT, OPEN, LOAD, 1X-THRU, and 2X-THRU
Intra-lane Skew (ps)	-6		6	All lanes and Aux CH, including mated Receptacle and Plug
Inter-lane Skew (ps)	-20		20	All lanes and Aux CH, including mated Receptacle and Plug
NEXT (dB), at 10.8 GHz, at 6.75 GHz at 4.05 GHz	-30	-32 -37		All lanes and Aux CH, single aggressor, without mDP connector, with six-inch cables and terminations
Current Carrying (A)	0.5			DP_PWR and Return

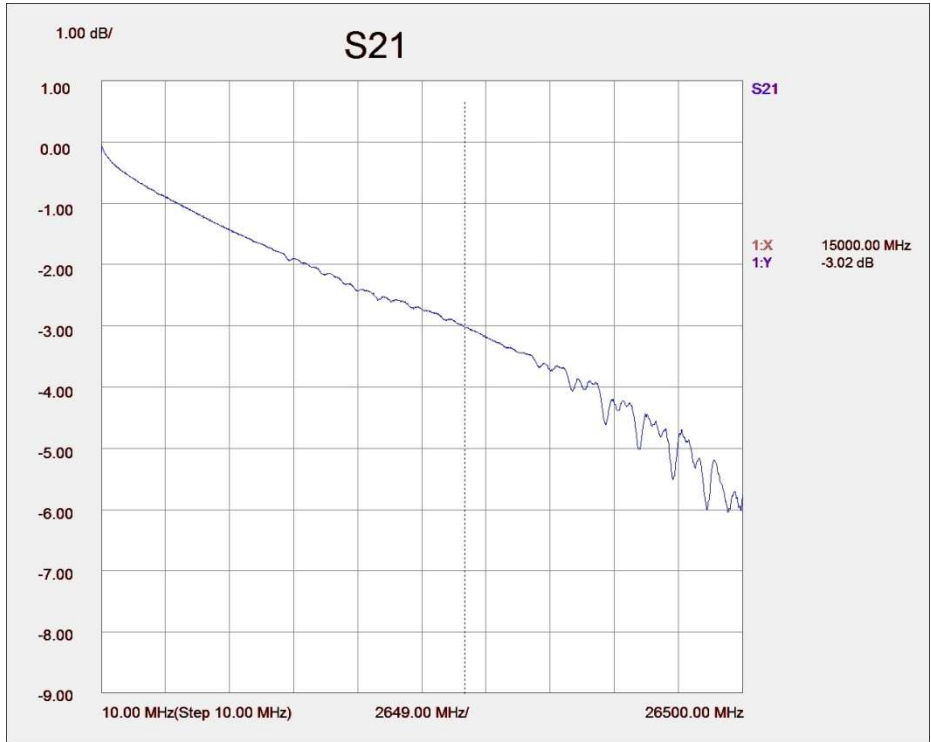

Figure 5. Typical 2X-THRU insertion loss

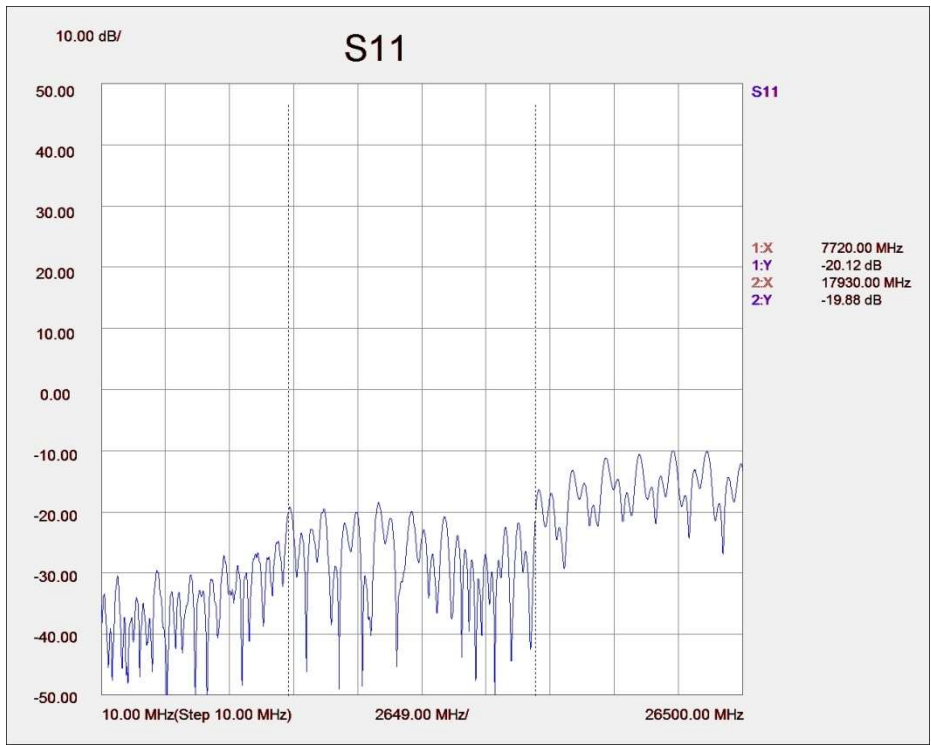

Figure 6. Typical 2X-THRU return loss

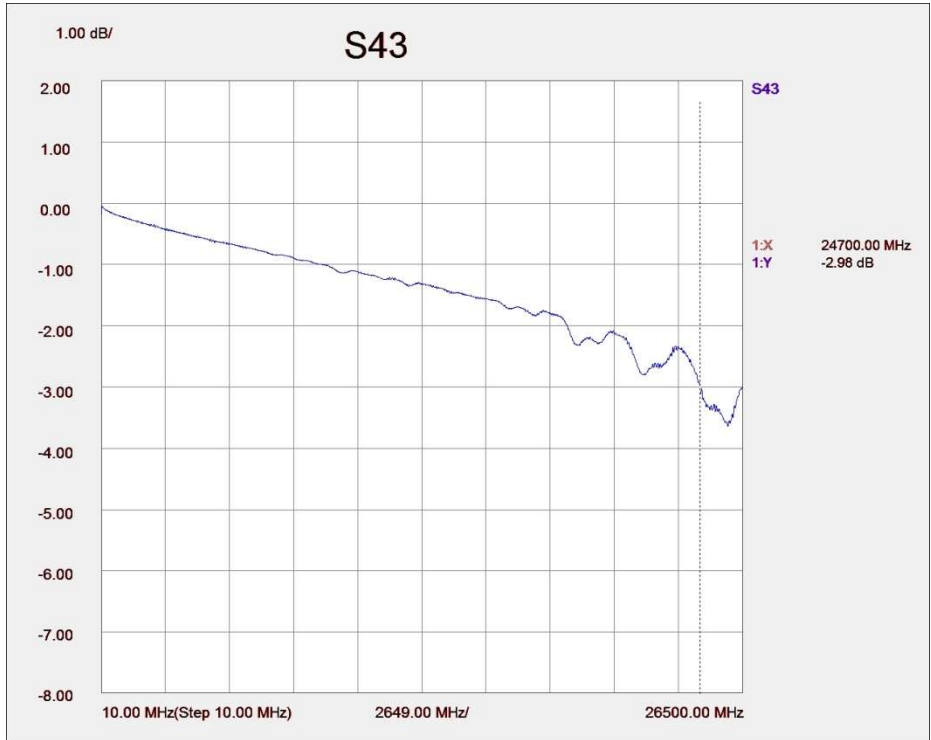

Figure 7. Typical 1X-THRU insertion loss

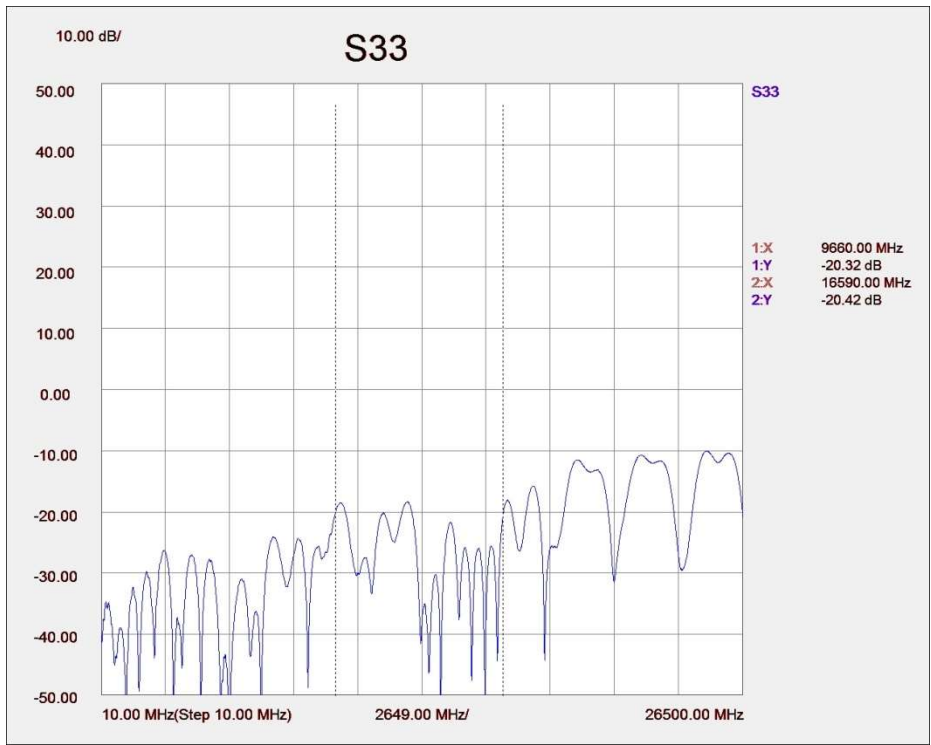

Figure 8. Typical 1X-THRU return loss

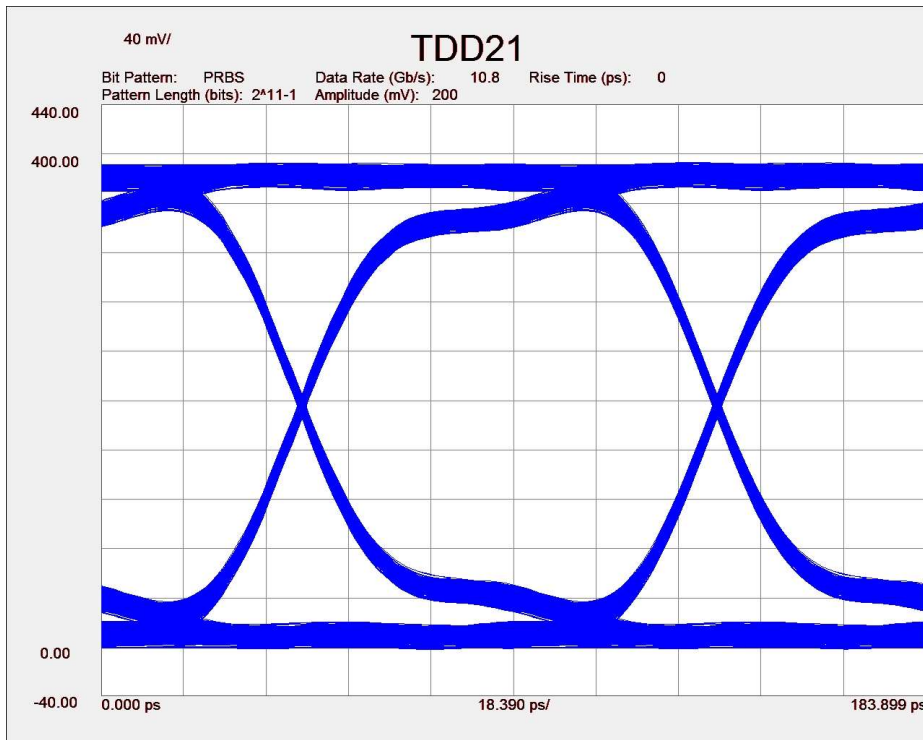
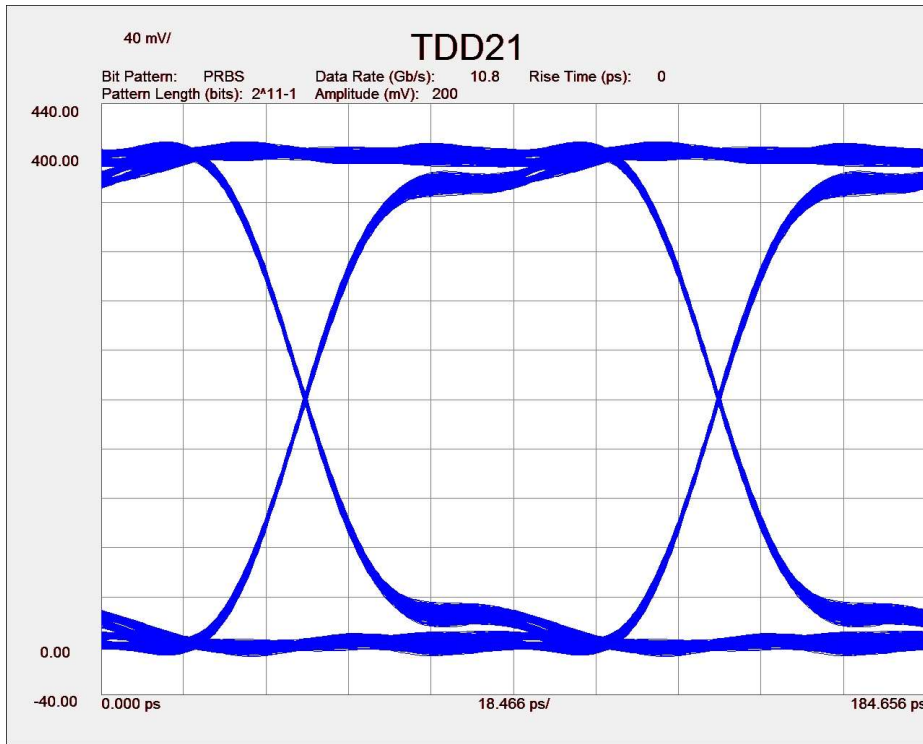

Figure 9. Typical mated pair 10.8 Gb/s eye diagram, with calibration (top) and without calibration (bottom)

Parameter Measurement Result

Name	Measurement Result
Eye Level Zero(mV)	10.28
Eye Level One(mV)	390.15
Eye Level Mean(mV)	200.22
Eye Amplitude(mV)	379.88
Eye Height(mV)	337.94
Eye Height(db)	-4.71
Eye Width	9.12e-011
Eye Opening Factor	0.89
Eye Signal_to_Noise	18.39
Eye Duty Cycle Dist	-1.39e-014
Eye Duty Cycle Dist(%)	-0.02
Eye Rise Time (20-80)	2.13e-011
Eye Fall Time (80-20)	2.13e-011
Eye Jitter(PP)	1.44e-012
Eye Jitter(RMS)	3.05e-013

S_n Param DUT Files Meas

Parameter Measurement Result

Name	Measurement Result
Eye Level Zero(mV)	23.37
Eye Level One(mV)	368.19
Eye Level Mean(mV)	195.78
Eye Amplitude(mV)	344.82
Eye Height(mV)	285.61
Eye Height(db)	-5.44
Eye Width	8.95e-011
Eye Opening Factor	0.83
Eye Signal_to_Noise	11.06
Eye Duty Cycle Dist	-2.07e-014
Eye Duty Cycle Dist(%)	-0.02
Eye Rise Time (20-80)	2.46e-011
Eye Fall Time (80-20)	2.46e-011
Eye Jitter(PP)	3.08e-012
Eye Jitter(RMS)	6.17e-013

S_n Param DUT Files Meas

Figure 10. Typical mated pair 10.8 Gb/s eye measurements, with calibration (top) and without calibration (bottom)

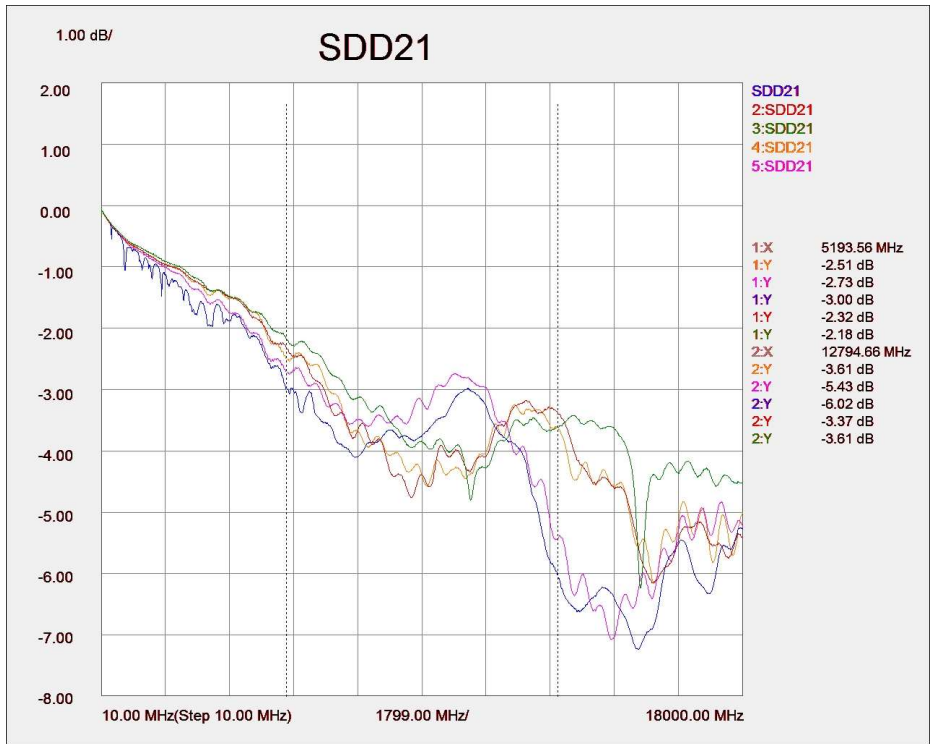
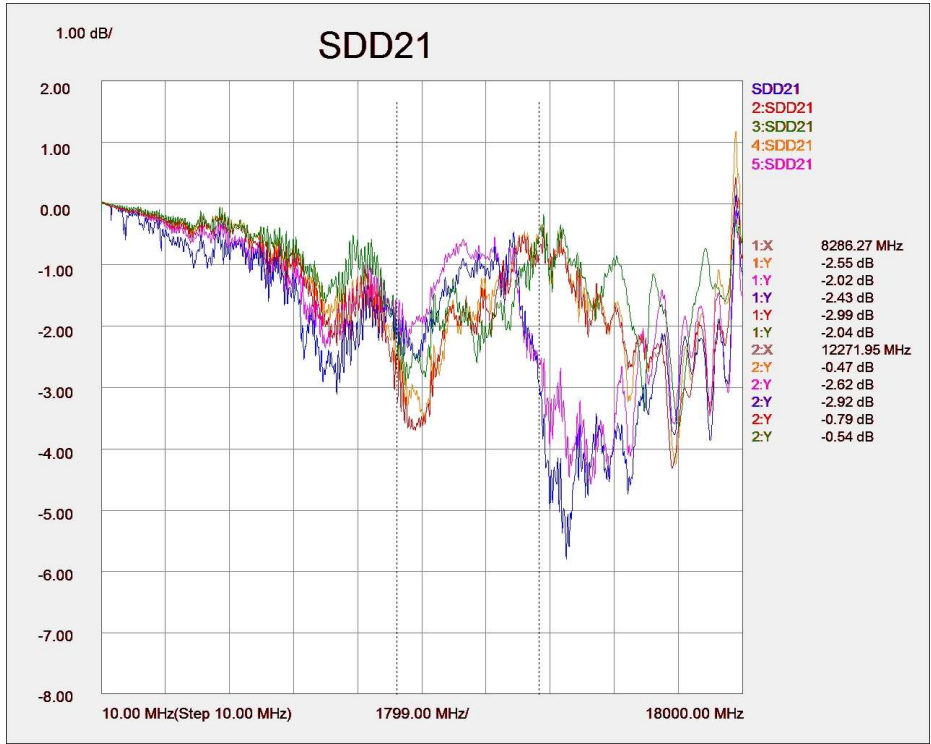

Figure 11. Typical mated pair balanced insertion loss, with calibration (top) and without calibration (bottom)

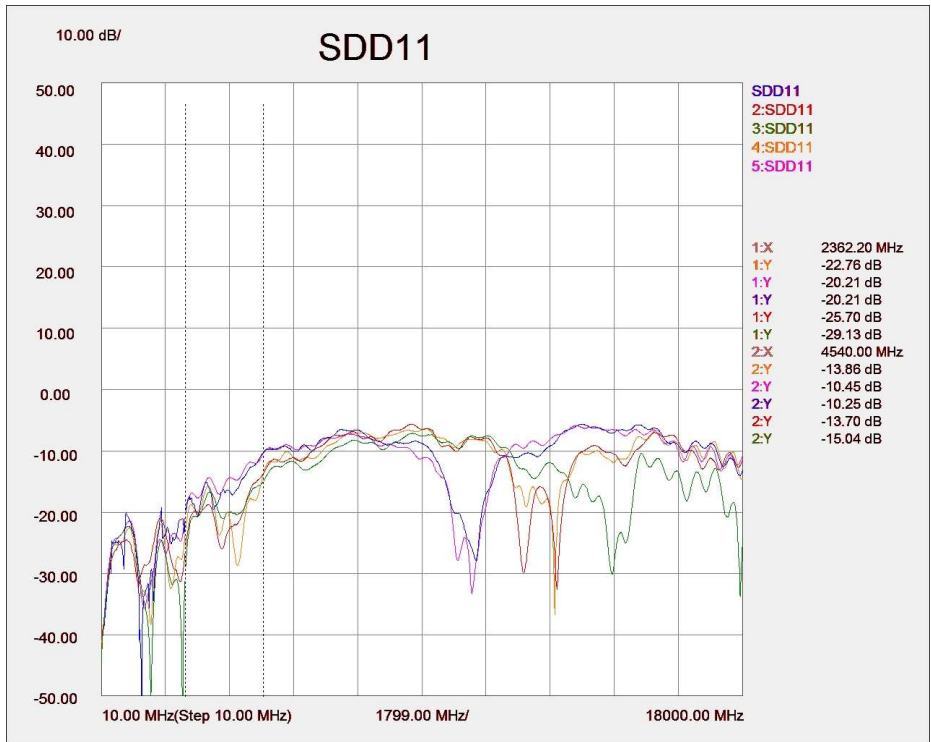
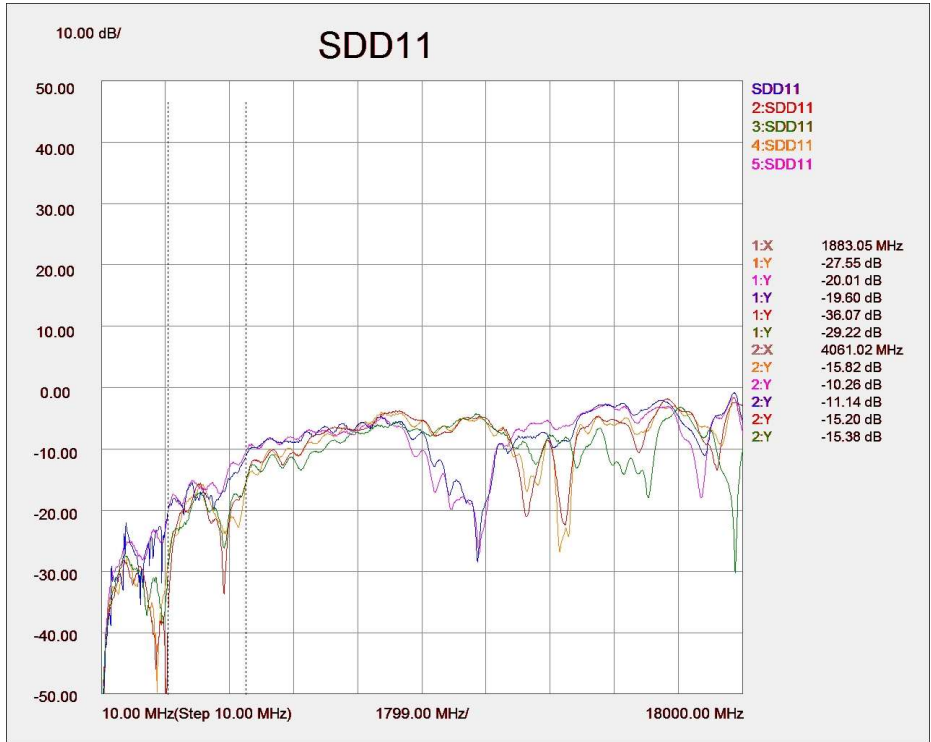

Figure 12. Typical mated pair balanced return loss, with calibration (top) and without calibration (bottom)

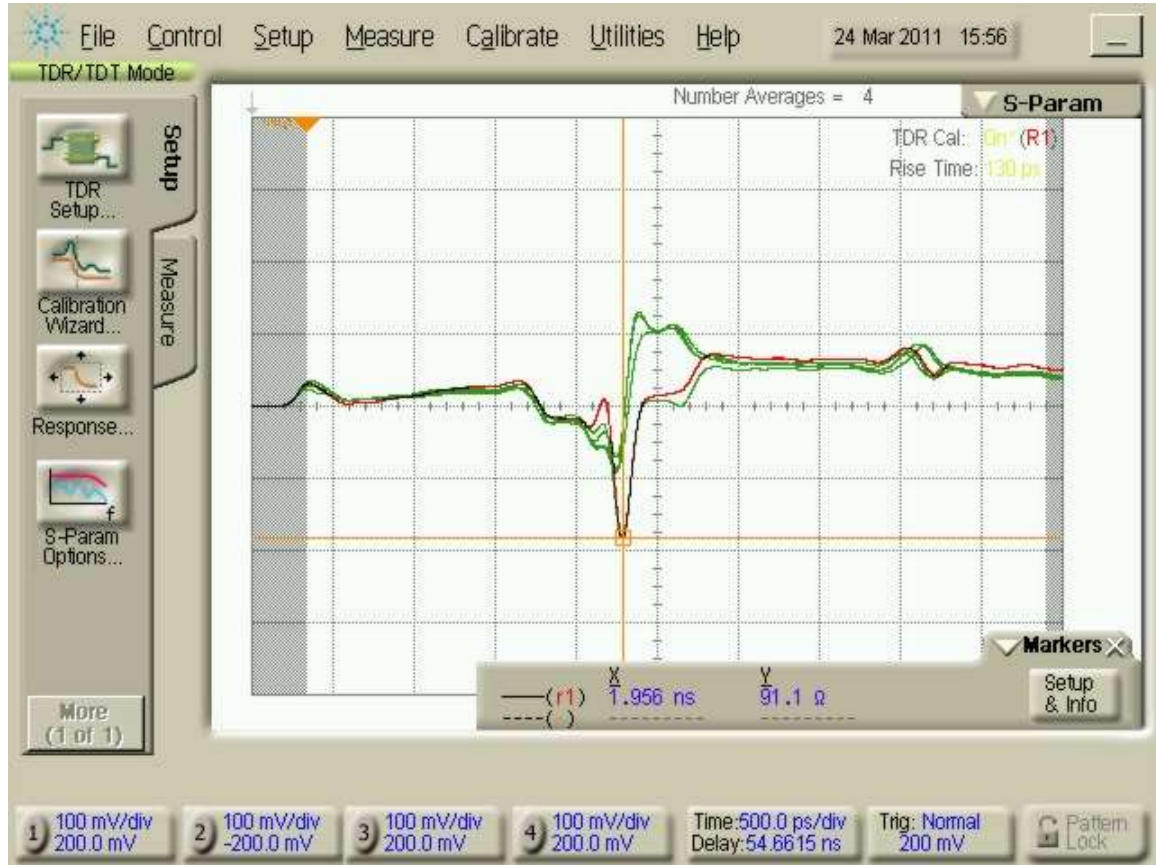

Figure 13. Typical Differential TDR of TPA-P connected to TPA-R at 130 ps Rise Time

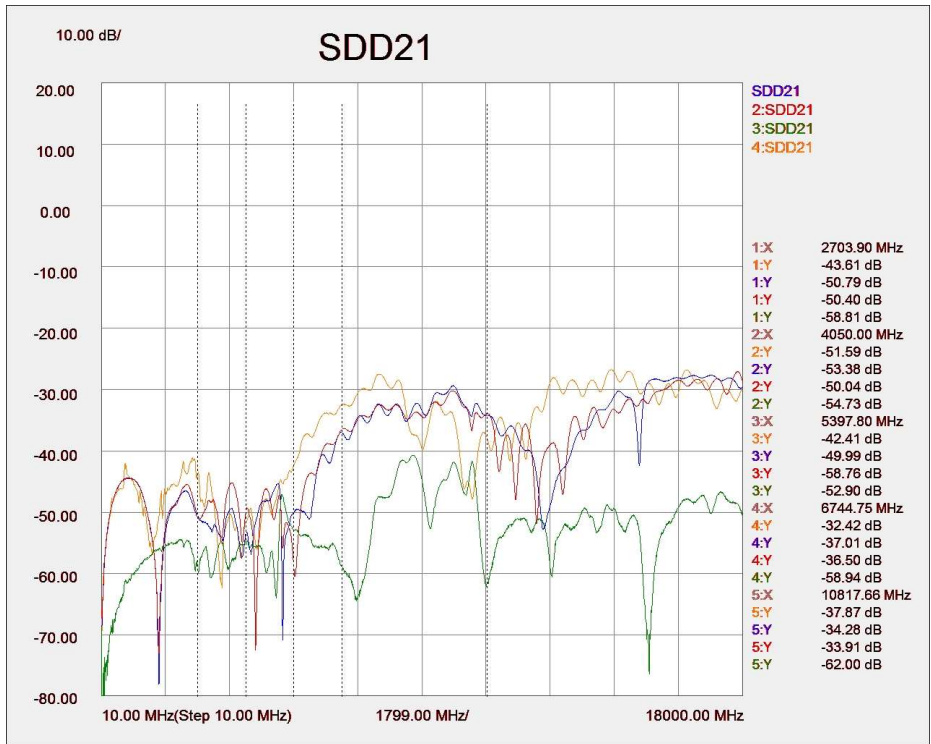
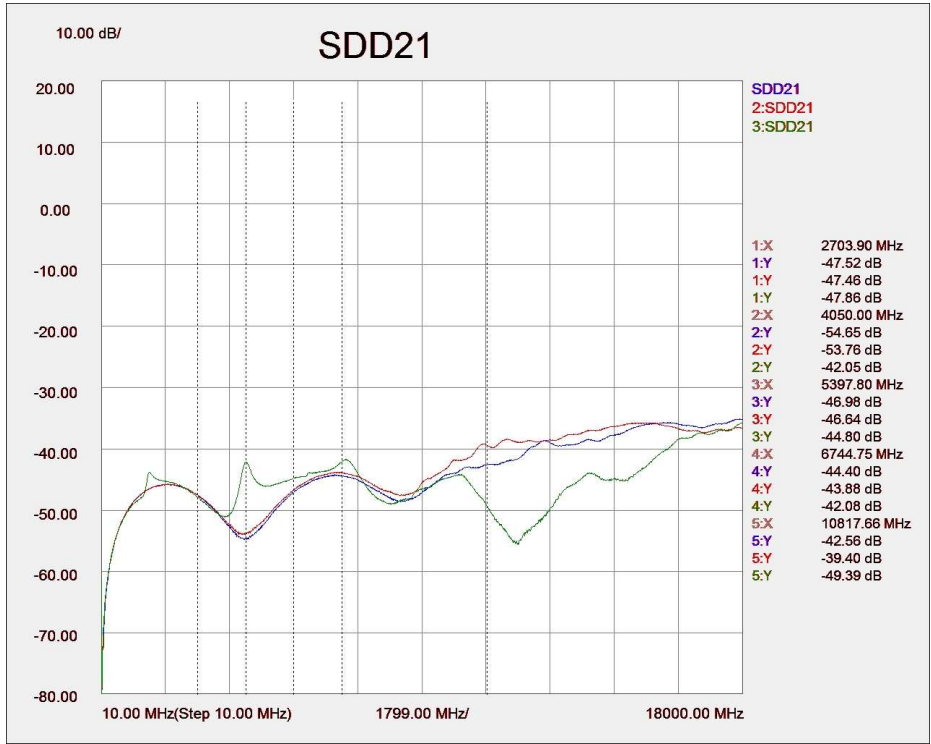

Figure 14. Typical Differential NEXT for Plug TPA, without connector (top) and with mated connectors, adjacent numbered lanes, all lanes terminated at both ends

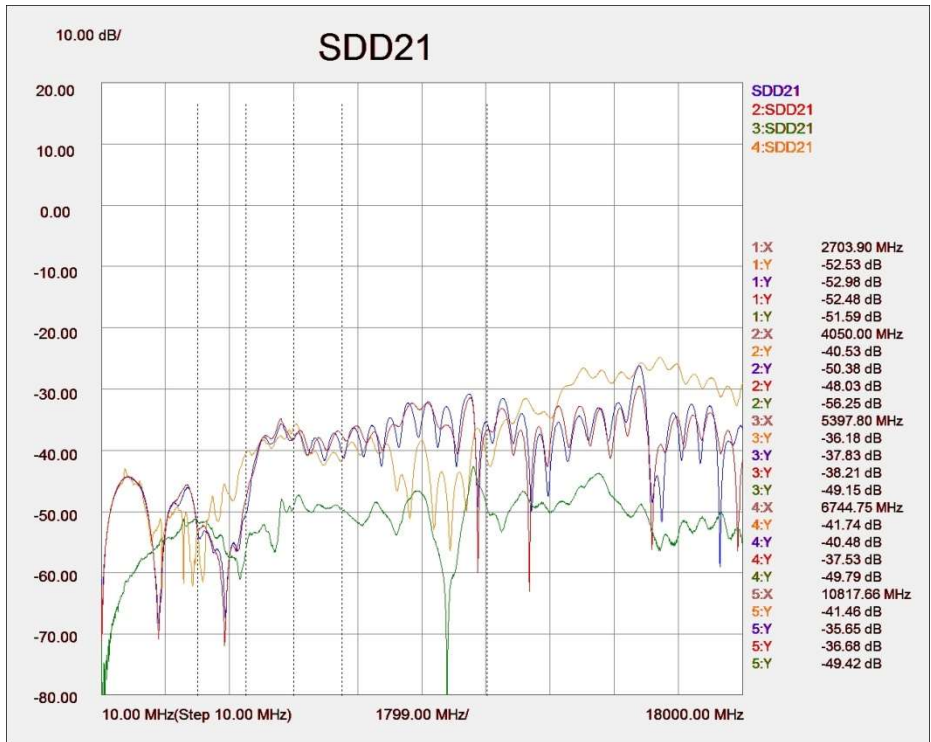
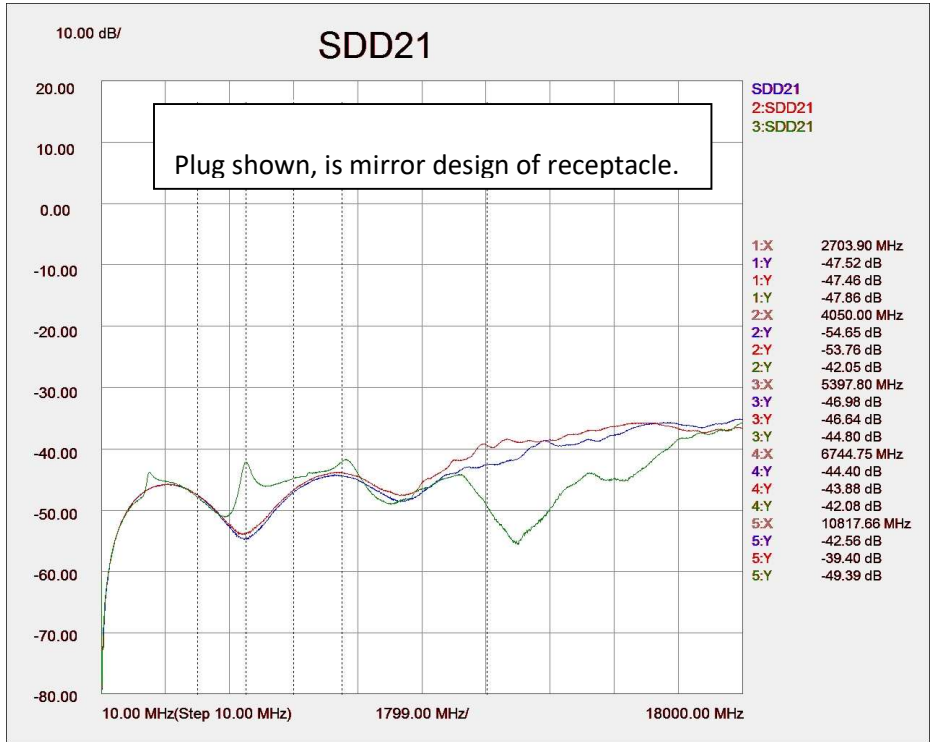

Figure 15. Typical Differential NEXT for Receptacle TPA, without connector (top) and with mated connectors, adjacent numbered lanes, all lanes terminated at both ends

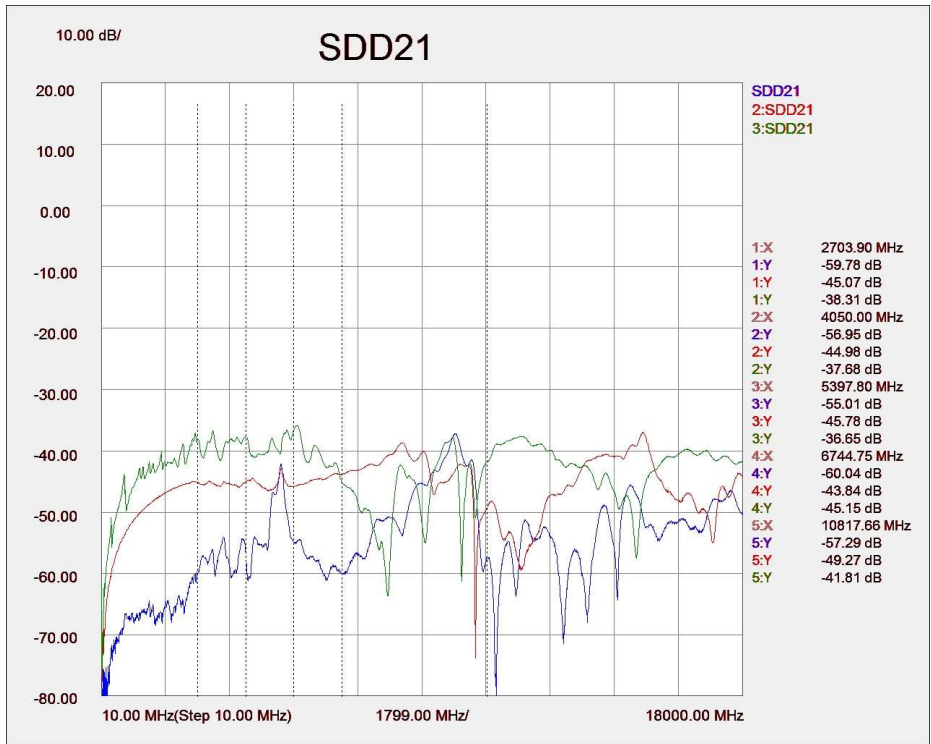
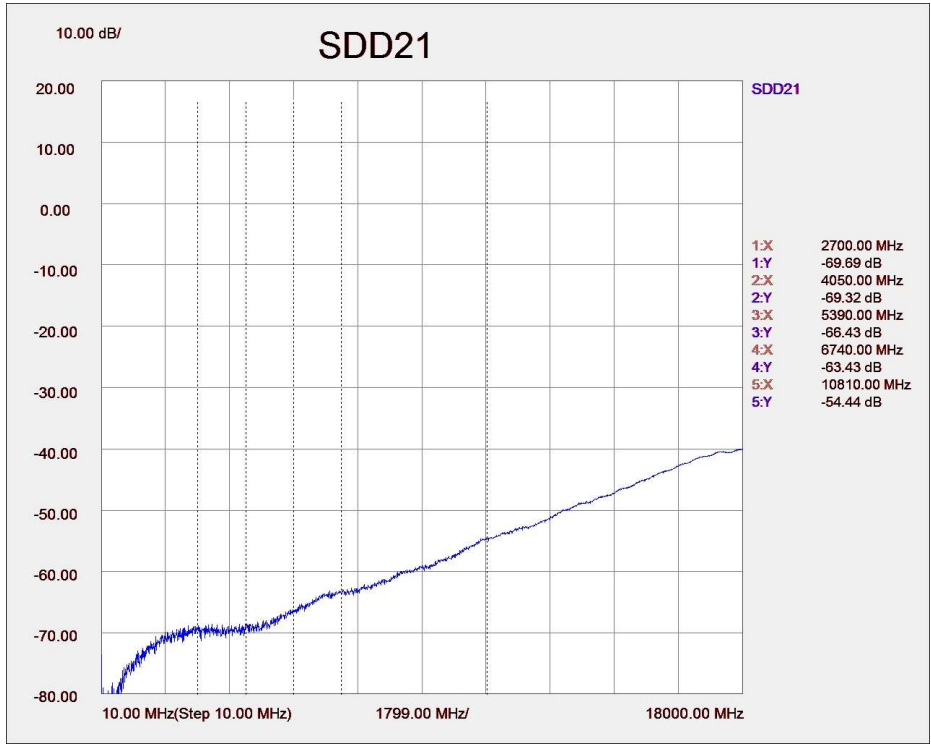

Figure 16. Typical Differential NEXT for Plug TPA, without connector (top) and with mated connectors; skipped lanes, even to even or odd to odd; all lanes terminated at both ends

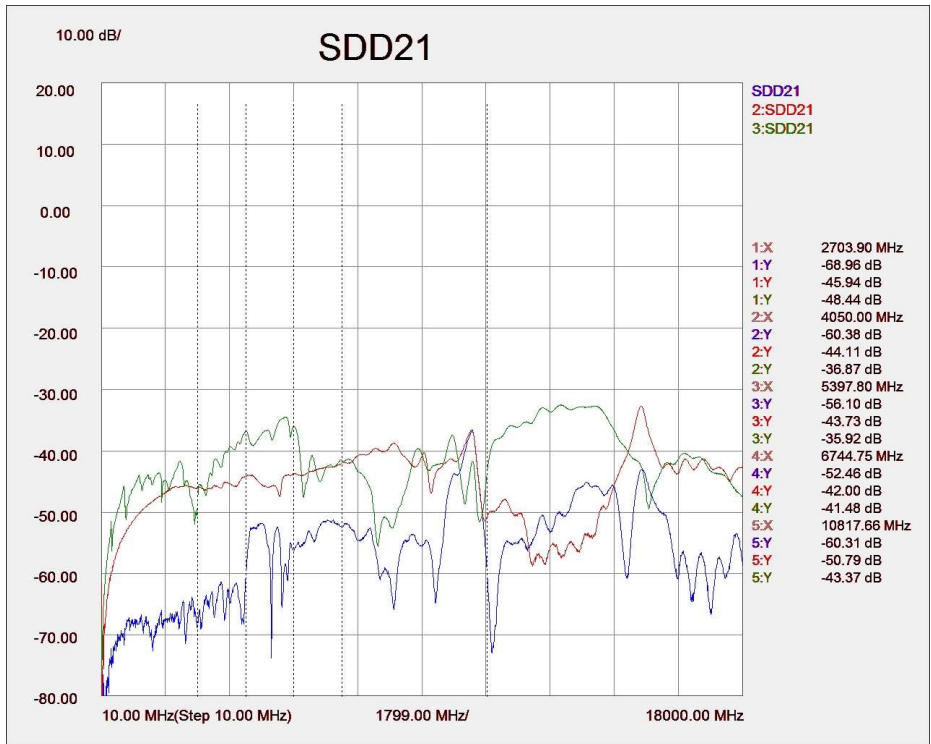
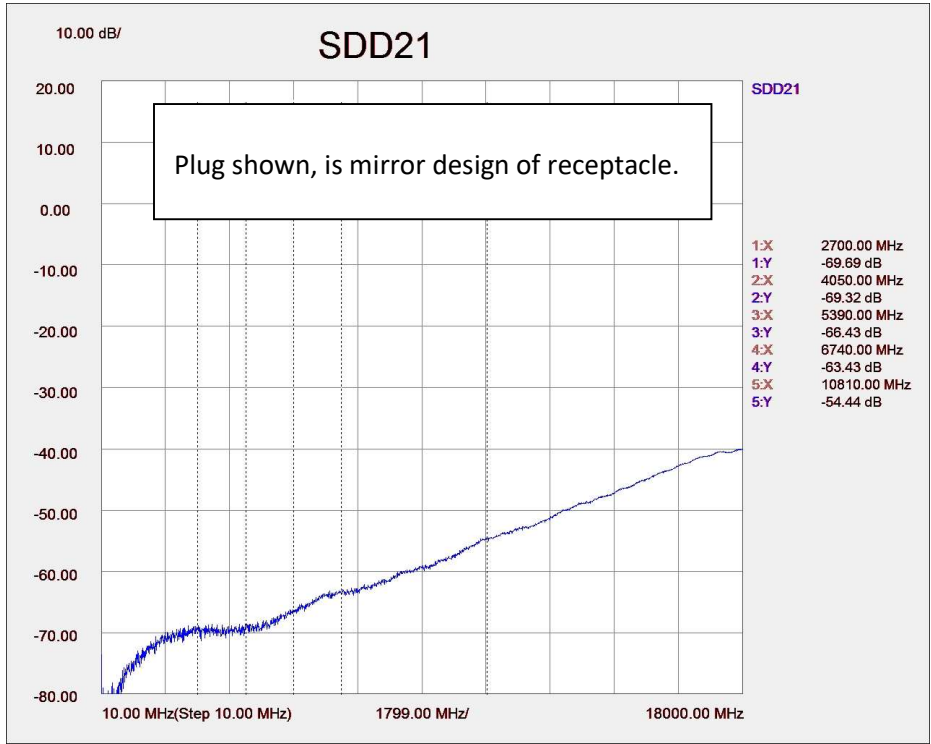

Figure 17. Typical Differential NEXT for Receptacle TPA, without connector (top) and with mated connectors; skipped lanes, even to even or odd to odd; all lanes terminated at both ends

Wilder Technologies, LLC – Limited Warranty

WILDER TECHNOLOGIES, LLC, warrants that the item(s) manufactured under the Buyer's contract shall be free from defects in materials and workmanship furnished by WILDER TECHNOLOGIES, LLC, and shall conform to the applicable drawings and specifications.

The warranty period for a Test Adapter is a specified, fixed period commencing on the date of ship from Wilder Technologies, LLC. If you did not purchase your Test Adapter directly from Wilder Technologies, LLC, the serial number and a valid proof of purchase will be required to establish your purchase date. If you do not have a valid proof of purchase, the warranty period will be measured from the date of ship from Wilder Technologies, LLC.

If, during the warranty period, the Test Adapter is not in good working order, Wilder Technologies, LLC will, at its option, repair or replace it at no additional charge, except as is set forth below. In some cases, the replacement Test Adapter may not be new and may have been previously installed. Regardless of the Test Adapter's production status, Wilder Technologies, LLC appropriate warranty terms apply.

Consumable and Fragile Material Warranty

Wilder Technologies, LLC warrants that consumable materials and all fragile materials supplied by Wilder Technologies, LLC either as part of an instrument or system, or supplied separately, will be free from defects in material and workmanship at the time of shipment.

Extent of Warranty

The warranty does not cover the repair or exchange of a Test Adapter resulting from misuse, accident, modification, unsuitable physical or operating environment, improper maintenance by you, or failure caused by a product for which Wilder Technologies, LLC is not responsible. The warranty is voided by removal or alteration of Test Adapter or parts identification labels. The initial three months are unconditional; the remaining months excludes plugs, receptacles and SMA connectors. Connectors are wear items and excluded from the warranty after the initial three months.

These warranties are your exclusive warranties and replace all other warranties or conditions, express or implied, including but not limited to, the implied warranties or conditions of merchantability and fitness for a particular purpose. These warranties give you specific legal rights and you may also have other rights which vary from jurisdiction to jurisdiction. Some jurisdictions do not allow the exclusion or limitation of express or implied warranties, so the above exclusion or limitation may not apply to you. In that event, such warranties are limited in duration to the warranty period. No warranties apply after that period.

Items Not Covered by Warranty

Wilder Technologies, LLC does not warrant uninterrupted or error-free operation of a Test Adapter.

Any technical or other support provided for a Test Adapter under warranty, such as assistance via telephone with "how-to" questions and those regarding Test Adapter set-up and installation, will be provided **WITHOUT WARRANTIES OF ANY KIND**.

Warranty Service

Warranty service may be obtained from Wilder Technologies, LLC by returning a Wilder Technologies, LLC Returns Material Authorization and the Test Adapter to Wilder Technologies, LLC during the warranty period. To obtain RMA number, contact support@wilder-tech.com.

You may be required to present proof of purchase or other similar proof of warranty entitlement. You are responsible for any associated transportation charges, duties and insurance between you and Wilder Technologies, LLC. In all instances, you must ship Test Adapters in Wilder Technologies, LLC approved packaging. Information on packaging guidelines can be found at: www.wilder-tech.com. Wilder Technologies, LLC will ship repaired or replacement Test Adapter Delivery Duty Prepaid (DDP) and will pay for return shipment. You will receive title to the repaired or replacement Test Adapter and you will be the importer of record.

Wilder Technologies, LLC – Terms & Conditions of Sale

- Other Documents:** This Agreement may NOT be altered, supplemented, or amended by the use of any other document(s) unless otherwise agreed to in a written agreement signed by both you and Wilder Technologies, LLC. If you do not receive an invoice or acknowledgement in the mail, via e-mail, or with your Product, information about your purchase may be obtained at support@wilder-tech.com or by contacting your sales representative.
- Payment Terms, Orders, Quotes, Interest:** Terms of payment are within Wilder Technologies, LLC's sole discretion, and unless otherwise agreed to by Wilder Technologies, LLC, payment must be received by Wilder Technologies, LLC prior to Wilder Technologies, LLC's acceptance of an order. Payment for the products will be made by credit card, wire transfer, or some other prearranged payment method unless credit terms have been agreed to by Wilder Technologies, LLC. Invoices are due and payable within the time period noted on your invoice, measured from the date of the invoice. Wilder Technologies, LLC may invoice parts of an order separately. Your order is subject to cancellation by Wilder Technologies, LLC, in Wilder Technologies, LLC's sole discretion. Unless you and Wilder Technologies, LLC have agreed to a different discount, Wilder Technologies, LLC's standard pricing policy for Wilder Technologies, LLC-branded systems, which includes hardware, software and services in one discounted price, allocates the discount off list price applicable to the service portion of the system to be equal to the overall calculated percentage discount off list price on the entire system. Wilder Technologies, LLC is not responsible for pricing, typographical, or other errors in any offer by Wilder Technologies, LLC and reserves the right to cancel any orders resulting from such errors.
- Shipping Charges; Taxes; Title; Risk of Loss:** Shipping, handling, duties and tariffs are additional unless otherwise expressly indicated at the time of sale. Title to products passes from Wilder Technologies, LLC to Customer on shipment from Wilder Technologies, LLC's facility. Loss or damage that occurs during shipping by a carrier selected by Wilder Technologies, LLC is Wilder Technologies, LLC's responsibility. Loss or damage that occurs during shipping by a carrier selected by you is your responsibility. You must notify Wilder Technologies, LLC within 7 days of the date of your invoice or acknowledgement if you believe any part of your purchase is missing, wrong or damaged. Unless you provide Wilder Technologies, LLC with a valid and correct tax exemption certificate applicable to your purchase of Product and the Product ship-to location, you are responsible for sales and other taxes associated with the order. **Shipping dates are estimates only.**
- WARRANTY:** WILDER TECHNOLOGIES, LLC, warrants that the item(s) manufactured under the Buyer's contract shall be free from defects in materials and workmanship furnished by WILDER TECHNOLOGIES, LLC, and shall conform to the applicable drawings and specifications. WILDER TECHNOLOGIES, LLC'S liability herein, for breach of warranty, contract or negligence in manufacturing, shall be limited to repair or replacement. Repair or replacement of defective items will be applicable only if the Buyer notifies WILDER TECHNOLOGIES, LLC, by written notice within 30-days of delivery. All claims shall be addressed to: support@wilder-tech.com or WILDER TECHNOLOGIES, LLC, 6101A East 18th Street, Vancouver, Washington 98661 U.S.A.; ATTENTION: Customer Service Manager. WILDER TECHNOLOGIES, LLC, reserves the right to inspect at the Buyer's plant all items claimed to be defective or nonconforming prior to authorizing their return. WILDER TECHNOLOGIES, LLC, assumes no liability for the results of the use of its components in conjunction with other electric, electronic or mechanical components, circuits and/or systems. The foregoing constitutes the sole and exclusive remedy of the Buyer and the exclusive liability of WILDER TECHNOLOGIES, LLC, and is IN LIEU OF ANY AND ALL OTHER WARRANTIES, STATUTORY, IMPLIED OR EXPRESSED AS TO MERCHANTABILITY, FITNESS FOR THE PURPOSE SOLD, DESCRIPTION, QUALITY, and PRODUCTIVENESS OR ANY OTHER MATTER. Without limiting the foregoing, in no event shall WILDER TECHNOLOGIES, LLC, be liable for loss of use, profit or other collateral, or for special and/or consequential damages.
- RETURNED GOODS:** WILDER TECHNOLOGIES, LLC, will accept only those goods for return that have been authorized for return. All goods authorized for return shall be assigned a Returned Material Authorization (RMA) Number. The RMA Number shall be clearly marked on the shipping container(s) and all documentation accompanying the goods authorized for return. The RMA Number shall be assigned by WILDER TECHNOLOGIES, LLC pursuant to the conditions set forth in Paragraph 4, WARRANTY.
- UNITED STATES GOVERNMENT CONTRACTS:** In the event this offer is accepted under Government contract, WILDER TECHNOLOGIES, LLC, agrees to accept clauses required by Government regulations and to waive WILDER TECHNOLOGIES, LLC conditions inconsistent therewith. WILDER TECHNOLOGIES, LLC, certifies that it is a regular manufacturer or dealer of the goods and/or services offered herein and that the prices offered do not exceed those charged to any customer for like quantities, services or materials under the same conditions.

Compliance with Environmental Legislation

Wilder Technologies, LLC, is dedicated to complying with the requirements of all applicable environmental legislation and regulations, including appropriate recycling and/or disposal of our products.



WEEE Compliance Statement

The European Union adopted Directive 2002/96/EC on Waste Electrical and Electronic Equipment (WEEE), with requirements that went into effect August 13, 2005. WEEE is intended to reduce the disposal of waste from electrical and electronic equipment by establishing guidelines for prevention, reuse, recycling and recovery.

Wilder Technologies has practices and processes in place to conform to the requirements in this important Directive.

In support of our environmental goals, effective January 1st, 2009 Wilder Technologies, LLC has partnered with EG Metals Inc. – Metal and Electronics Recycling of Hillsboro, Oregon, www.egmetalrecycling.com, to recycle our obsolete and electronic waste in accordance with the European Union Directive 2002/96/EC on waste electrical and electronic equipment ("WEEE Directive").

As a service to our customers, Wilder Technologies is also available for managing the proper recycling and/or disposal of all Wilder Technologies products that have reached the end of their useful life. For further information and return instructions, contact support@wilder-tech.com.



Compliance to RoHS 2 Substance Restrictions

Wilder Technologies, LLC certifies that the parts described in this document are compliant to the substance restrictions of Directive 2011/65/EU and Amendment Directive (EU) 2015/863 of the European Parliament, and of the Council of 8 June, 2011 and 31 March, 2015 on the restriction of the use of certain hazardous substances in electrical and electronic equipment (RoHS 2 Directive), prohibiting the use in homogeneous materials in excess of the listed maximum concentration value, except in cases where use is allowed by applicable exemptions listed in Annex III and Annex IV of the Directive.

Compliance with RoHS 2 has been verified through internal controls at design and production sites, including establishment of processes for specifying and controlling materials and segregation of non-compliant parts, receipt of supplier declarations of compliance and/or analytical test.

Glossary of Terms

TERMINOLOGY	DEFINITION
Aggressor	A signal imposed on a system (i.e., cable assembly) to measure response on other signal carriers.
AUX Channel	Half-duplex, bi-directional channel between the DisplayPort transmitter and DisplayPort receiver. Consists of one differential pair transporting self-clocked data. The DisplayPort AUX Channel supports a bandwidth of 1Mbps over the DisplayPort link. DisplayPort Source is the master that initiates an AUX Channel transaction. DisplayPort Sink is the slave that replies to the AUX Channel transaction initiated by the Requester.
Box-to-box connection	DisplayPort link between two boxes detachable by an end user. A Mini DisplayPort cable-connector assembly for the box-to-box connection shall have four Main Link lanes.
DDC/CI	Display Data Channel/Command Interface (VESA)
DisplayPort Receiver	Circuitry that receives the incoming DisplayPort Main Link data. Also contains the transceiver circuit for AUX Channel. Located in Sink Device and the upstream port of Intermediate Device.
DisplayPort Transmitter	Circuitry that transmits the DisplayPort Main Link data. Also contains the transceiver circuit for AUX CH. Located in Source Device and in the downstream port of Intermediate Device.
mDPI-TPA	Mini DisplayPort Interoperability Test Point Access. A specialized assembly that interfaces to a Mini DisplayPort receptacle or plug and enables access to signals for measurement or stimulation. "Interoperability" allows access to Config1 and Config2.
Dual-standard Device Source or Sink	Device that supports both DisplayPort and DVI/HDMI operating modes.
Informative	The designation of a test that is not required for compliance but is considered important from a characterization standpoint. It is provided for informational purposes only.
Main Link	Unidirectional channel for isochronous stream transport from DisplayPort Source to DisplayPort Sink. Consists of one, 2, or 4 lanes, or differential pairs. Supports 3 bit rates: 5.4 Gb/s per lane (referred to as "High Bit Rate 2"), 2.7Gb/s per lane (referred to as "High Bit Rate") and 1.62Gb/s per lane (referred to as "Reduced Bit Rate").
Normative	The designation of a test that is required for compliance.
Sink Device	A device that contains A/V stream sinks for display and/or sound.
Source Device	A device that contains a stream source and originates an isochronous A/V stream.
Victim	A signal carrier on a system that has a response imposed on it by other signals in the system.

Index

- 1X-THRU, 15
- Cable Bend Limits, 6
- Cable Losses, 15
- Cable Tension (Pull Forces), 6
- Cable Twisting (Torque), 6
- Calibration, 13
- Calibration Through De-Embedding, 16
- Care and Handling, 6
- Cleaning, 8
- Compliance
 - WEEE, 34
- Config1, 3
- Config2, 3
- Connections
 - mDPI-TPA to DUT, 6
 - SMA, 7
- Crosstalk Errors, 14, 16
- De-Emphasis, 15
- Directivity Errors, 14, 16
- DisplayPort PHY CTS, 10
- DP Power, 3
- Drift Errors, 14, 16
- DUT, 14, 16
- Electrical Specifications, 20
- Electrostatic Discharge Information (ESD), 9
- Environmental Changes, 14, 16
- Errors
 - Crosstalk*, 14, 16
 - Directivity*, 14, 16
 - Drift*, 14, 16
 - Load Impedance Mismatching*, 14, 16
 - Random*, 14, 16
 - Receiver Reflection-Tracking in Test Equipment*, 14, 16
 - Receiver Transmission in Test Equipment*, 14, 16
 - Source Impedance Mismatching*, 14, 16
- ESD Protection, 9
- Figures
 - Cable Connectors, 17
 - Calibration Module, 13
 - The Mini DisplayPort Test Adapter (Plug), 3
 - The Mini DisplayPort Test Adapter (Receptacle), 4
- Glossary, 35
- Ground, 3
- Group Delay, 15
- Handling and Storage, 8
- Hot Plug Detect, 3
- Load Impedance Mismatching Errors, 14, 16
- Low-Speed Connector, 3, 4
- Low-Speed Connector Part Numbers, 4
- Making Connections, 8
- mDPI-TPA Cable Pinout, 17
- Mechanical and Environmental Specifications, 17
- Mini DisplayPort Plug TPA as a Sink, 10
- Mini DisplayPort Plug TPA as a Source, 11
- Mini DisplayPort Receptacle TPAs as Source & Sink, 12
- Molex Part Numbers, 4
- Pre-Emphasis, 15
- Product Inspection, 5
- Product Return, 5
- Pull Force, 7
- Random Errors, 14, 16
- Receiver Reflection-Tracking in Test Equip. Errors, 14, 16
- Receiver Transmission in Test Equip. Errors, 14
- Receiver Transmission in Test Equipment Errors, 16
- Secure Storage, 5
- SMA Connectors, 17
- SOLT, 14
- Source Impedance Mismatching Errors, 14, 16
- Support, 16, 33
- Supporting Instrument Cables or Accessories, 7
- Tables
 - Electrical Specifications, 20
 - General Specifications, 17
 - mDPI-TPA Six-Position Cable Connector, 18
 - Mini DisplayPort Plug & Receptacle Pin Assignments, 19
 - SMA Cable Connectors (High-Speed), 18
- Terms and Conditions of Sale, 33
- Test Instrument Noise, 14, 16
- Test Repeatability Problems, 14, 16
- User Model Examples, 10, 11, 12
- VESA DisplayPort™ PHY Compliance Test Spec., 3
- Visual Inspection, 8
- Warranty, 32
- Web Sites
 - support@wilder-tech.com, 32, 33
 - www.egmetalrecycling.com, 34
 - www.wilder-tech.com, 32
- WEEE, 34

Visit our website at www.wilder-tech.com



**WILDER
TECHNOLOGIES**

It's all about integrity

Wilder Technologies, LLC
11201 NE 9th St.
Vancouver WA, 98684
Phone: 360-859-3041
Fax: 360-859-3105
www.wilder-tech.com

© 2024 Wilder Technologies, LLC
Document No. 910-0017-000 Rev. F
Created: 6/9/2011 Revised: 2/29/2024