

PCIe Gen-5 M.2 Socket-3 Test Adapters

User Manual



WILDER
TECHNOLOGIES

It's all about integrity

Table of Contents

Table of Contents	2
Introduction.....	3
PCIe Gen-5 M.2 Socket-3 Accessories and Optional Accessories.....	4
PCIe Gen-5 M.2 Socket-3 Accessories	4
PCIe Gen-5 M.2 Socket-3 Optional Accessories	5
Product Inspection	6
The PCIe Gen-5 M.2 Socket-3 Test Adapters and Handling Precautions	7
General Test Adapters, Cable, and Connector	9
Handling and Storage	9
Visual Inspection.....	9
Cleaning	9
Making Connections	9
Electrostatic Discharge Information	10
User Models	11
CMTS Board Features	11
CBB Test Fixture Features.....	15
CLB Test Fixture Features	21
TX Testing User Models	22
RX Testing User Models.....	23
110-1242-100 and 110-1242-200 (CLB) RF signal breakout summary.....	25
Mechanical and Environmental Specifications.....	26
Electrical Specifications	29
Typical High-Speed Serial Characteristics.....	30
Characterization (CLB and CBB Independent Only)	30
Compliance with Environmental Legislation	35
WEEE Compliance Statement.....	35
Compliance To RoHS 2 Substance Restrictions	35
Glossary of Terms	36
Index	37

Introduction

This user's guide documents the PCIe Gen-5 M.2 Socket-3 Test Adapters. The Test Adapters shown in Figure 1, tests PCIe Gen-5 M.2 Socket-3 hosts and devices against the PCIe Specification. The model numbers for the PCIe Gen-5 M.2 Socket-3 Test Adapters are as follows:

Table 1. Available Models

MODEL NUMBERS	DESCRIPTION
PCIEG5-M2-TPA3-CLB	CLBs + CMTS + Accessories
PCIEG5-M2-TPA3-CBB	CBB + CMTS + Accessories
PCIEG5-M2-TPA3-CLBCBB	CLBs + CBB + CMTS (2x) + Accessories
PCIE-CTMS-TPA	CMTS

The CLB and CBB Test Adapters fixtures allow easy access, via high-speed MMPX connections, to measure or inject data signals.

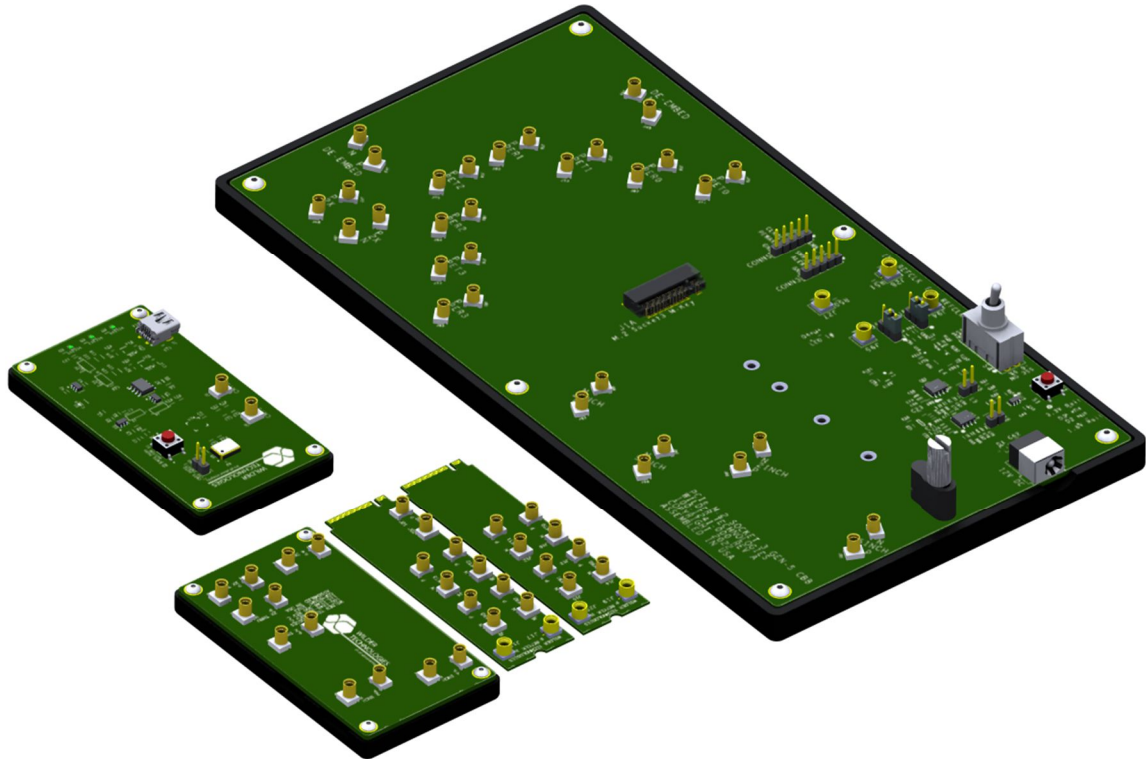

Figure 1. PCIe Gen-5 M.2 Socket-3 Test Adapters

PCIe Gen-5 M.2 Socket-3 Accessories and Optional Accessories

PCIe Gen-5 M.2 Socket-3 Accessories

The PCIEG5-M2-TPA3 Test Adapters are provided with the following materials in Figure 22 that allow the user to properly interface with the fixtures and/or DUT. The power supply and power cord are only included with the PCIEG5-M2-TPA3-CBB for power. A 2.92mm female to SMP female 9" cable assembly pair is included with each PCIEG5-M2-TPA3-CBB and PCIEG5-M2-TPA3-CLB model. Lastly, one Wilder CMTS Interface 12" cable assembly pair is included with each PCIE-CTMS-TPA model, exclusively to be used as a CMTS interface cable only.

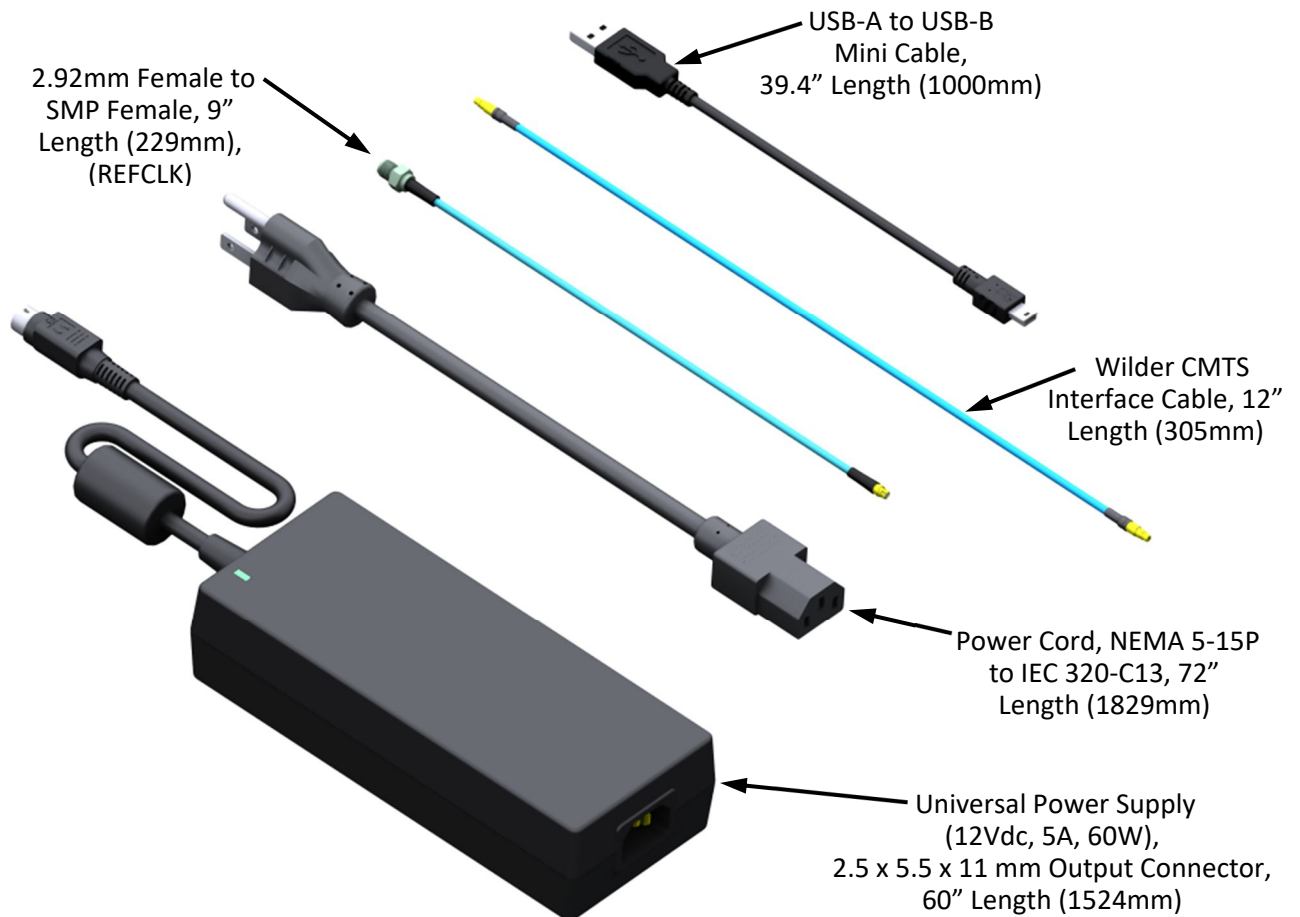

Figure 2. The PCIe Gen-5 M.2 Socket-3 included accessories (NOT modeled to scale)

PCIe Gen-5 M.2 Socket-3 Optional Accessories

There are numerous Huber+Suhner PCIe Gen-5 accessories, such as adapters or cable assemblies, available for purchase from Richardson RFPD. The table below indicates the Huber+Suhner part numbers for the optional accessories.

Table 2. Optional PCIe Gen-5 Accessories from Richardson RFPD

HUBER+SUHNER PART NUMBER	HUBER+SUHNER DESCRIPTION	DETAILS
84071648	33MMPX-SK-50-1E	RF Adapter – Between series MMPX Male to SK (2.92 mm) Female
84071696	33SK-MMPX-50-1E	RF Adapter – Between series SK Male to MMPX Female
80351638	024E573HTCR092HTCR2.5PM1PS-STD	RF Cable – SMP Female to SMA Female, 2.5" Long (63.5 mm)
85105115	PCI SF102E/11SK/11SK/914mm	RF Cable – SK Male to SK Male, 36" Long (914 mm)
85108590	PMA SF102E/11MMPX/11MMPX/305mm	RF Cable – MMPX Male to MMPX Male, 12" Long (305 mm)
85119609	024E430CR092KCR4PM1PS-STD	RF Cable – MMPX Male to SK Female, 4" Long (102 mm)
85152826	PCI SF102E/11MMPX/11SK/914mm	RF Cable – MMPX Male to SK Male, 36" Long (914 mm)
85174413	PCI 65_MMPX Kit	MMPX 50-Ohm Terminator Kit

NOTE: To avoid damaging attaching cables or the test adapters, use the handling techniques described in the Care and Handling section before making any connections or configuring a test setup.

Always use a static-safe workstation when performing tests, as explained in the “Electrostatic Discharge Information” section.

Product Inspection

Upon receiving the PCIe Gen-5 M.2 Socket-3 Test Adapters from Wilder Technologies, perform the following product inspection:

- Inspect the outer shipping container, foam-lined instrument case, and product for damage. Retain the outer cardboard shipping container until the contents of the shipment have been inspected for completeness and the product has been checked mechanically and electrically. Use the foam-lined instrument-case for secure storage of the Wilder Technologies PCIe Gen-5 M.2 Socket-3 Test Adapters when not in use.
- Locate the shipping list and verify that all items ordered were received.
- In the unlikely event that the product is defective or incomplete, the “Limited Warranty” (see the Wilder web site) discusses how to contact Wilder Technologies for technical assistance and/or how to package the product for return.

The PCIe Gen-5 M.2 Socket-3 Test Adapters and Handling Precautions

The PCIe Gen-5 M.2 Socket-3 Test Adapters require careful handling to avoid damage. Improper handling techniques, or using too small of a cable bend radius, can damage the coaxial cable connections. This can occur at any point along the cable. To achieve optimum performance and to prolong the PCIEG5-M2-TPA3 Test Adapters' life, observe the following handling precautions:

- **CAUTION 1: Avoid Torque Forces (Twisting)**
While individual coaxial cables mating to the fixture may have some rotational freedom, twisting the fixture as a unit, with one end held stationary, may damage, or severely degrade performance. Adherence to Caution 5 (below) helps to avoid twisting.
- **CAUTION 2: Avoid Sharp Cable Bends**
Never bend coaxial cables into a radius of 26 mm (1-inch) or less. Never bend cables greater than 90°. Single or multiple cable bends must be kept within this limit. Bending mated cables to the fixture less than a 26mm (1-Inch) radius will permanently damage or severely degrade overall performance.
- **CAUTION 3: Avoid Cable Tension (Pull Forces)**
Never apply tension (pull forces) to an individual coaxial cable that is greater than 2.3 kg (5 lbs.). To avoid applying tension, always place accessories and equipment on a surface that allows adjustment to eliminate tension on the cables. Use adjustable elevation stands or apparatus to accurately place and support the fixture.

If the test set-up requires repositioning, first loosen, or disconnect the cable connections to avoid twisting, bending, or tension.

- **CAUTION 4: Independently Support Instrument Cables or Accessories**
Excessive weight from instrument cables and/or accessories connected to the test fixtures can cause damage or affect the test fixture's performance. Be sure to provide appropriate means to support and stabilize all test set-up components.
- **CAUTION 5: Observe M.2 (NGFF) Mini-Card Module Insertion/Removal Instructions**
Users that are unfamiliar with the M.2 (NGFF) connector interface and the associated module insertion and removal process are encouraged to review Tyco Electronics document 114-115006, Section 3.13 for guidance (see link, below and the extracted guideline section on the following page). *(Courtesy of TE Connectivity)*

http://www.te.com/commerce/DocumentDelivery/DDEController?Action=showdoc&DocId=Specification+Or+Standard%7F114-115006%7FA%7Fpdf%7FEnglish%7FENG_SS_114-115006_A.pdf%7FN-A

- **CAUTION 5 (Continued): M.2 (NGFF) Mini-Card Module Insertion/Removal Instructions**
 Extracted from Tyco Electronics Application Note 114-115006 (Courtesy of TE Connectivity).



3.13. Module Insertion and Removal Process

A. Module Insertion Process for 2.25H, 3.2H, and 4.2H

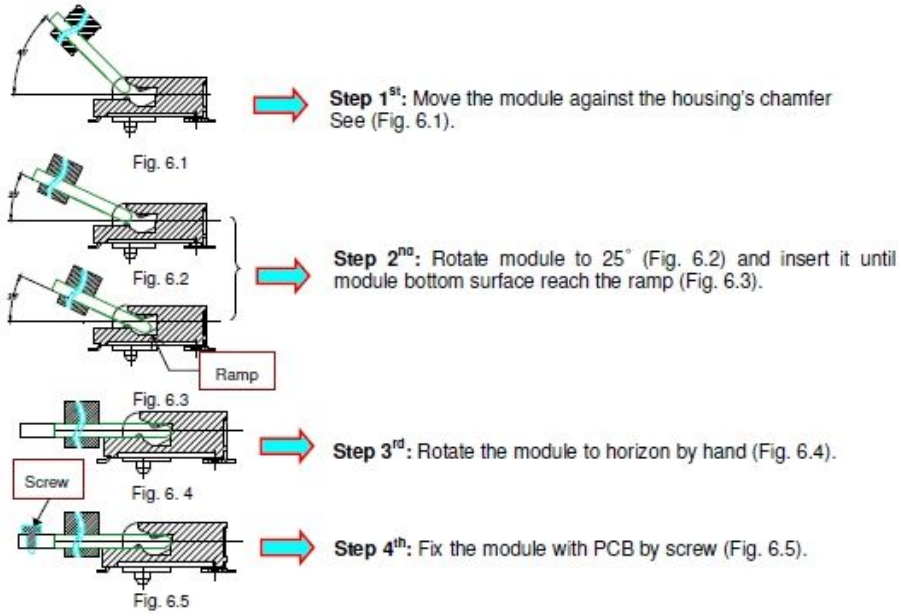

B. Module Removal Process for 2.25H, 3.2H, and 4.2H

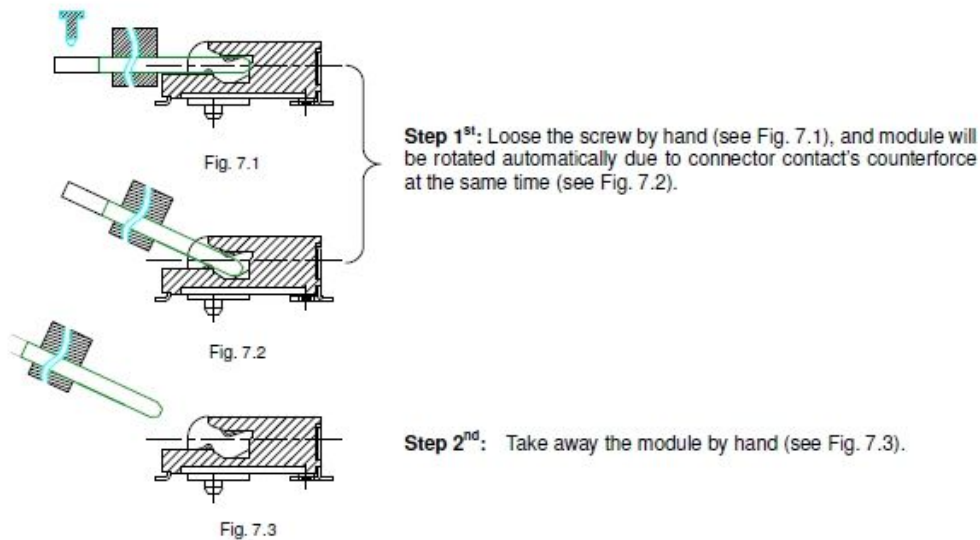

Figure 3. M.2 Mini-Card Module Insertion/Removal Instructions

General Test Adapters, Cable, and Connector

Observing simple precautions can ensure accurate and reliable measurements.

Handling and Storage

Before each use of the PCIEG5-M2-TPA3 test fixtures, ensure that all connectors are clean. Handle all cables carefully and store the test fixtures in the foam-lined instrument case when not in use, if possible. Do not set connectors contact end down. Install the MMPX protective end caps when the test fixtures are not in use.

Visual Inspection

Be sure to inspect all cables and MMPX connectors carefully before making a connection. Inspect all cables for metal particles, scratches, deformed threads, dents, or bent, broken, or misaligned center conductors. Do not use damaged cables.

Cleaning

If necessary, clean the connectors using low-pressure (less than 60 PSI) compressed air or nitrogen with an effective oil-vapor filter and condensation trap. Clean the cable threads, if necessary, using a lint-free swab or cleaning cloth moistened with isopropyl alcohol. Always completely dry the connector before use. Do not use abrasives to clean the connectors. Re-inspect connectors, making sure no particles or residue remains.

Making Connections

Before making any connections, review the “Care and Handling Precautions” section. Follow these guidelines when making connections:

- Align cables carefully
- Make preliminary connection lightly
- To tighten, turn connector nut only
- Do not apply bending force to cable
- Do not over-tighten preliminary connections
- Do not twist or screw-in cables
- Use an appropriately sized torque wrench, and do not tighten past the “break” point of the torque wrench (normally set to 5-inch pounds)

Electrostatic Discharge Information

Protection against electrostatic discharge (ESD) is essential while connecting, inspecting, or cleaning the PCIEG5-M2-TPA3 test adapters and connectors attached to a static-sensitive circuit (such as those found in test set).

Electrostatic discharge can damage or destroy electronic components. Be sure to perform all work on electronic assemblies at a static-safe workstation, using two types of ESD protection:

- Conductive table-mat and wrist-strap combination
- Conductive floor-mat and heel-strap combination

When used together, both types provide a significant level of ESD protection. Used alone, the table-mat and wrist-strap combination provide adequate ESD protection. To ensure user safety, the static-safe accessories must provide at least 1 M Ω of isolation from ground. Acceptable ESD accessories may be purchased from a local supplier.

WARNING: These techniques for a static-safe workstation should not be used when working on circuitry with a voltage potential greater than 500 volts.

User Models

The PCIEG5-M2-TPA3 test adapters support electrical testing of PCIe Specification. It can perform well beyond the scope of measurements required, limited only by the specifications, environmental, care and handling as stated in this document.

Note: The PCIe Gen-5 CEM Variable ISI board (PCIe-VAR-ISI) is required for achieving total channel loss of TX test setup as well as system RX and AIC RX calibrations. Other accessories required for validation can be purchased from Richardson RFPD (refer to the PCIe Gen-5 M.2 Socket-3 Optional Accessories section).

CMTS Board Features

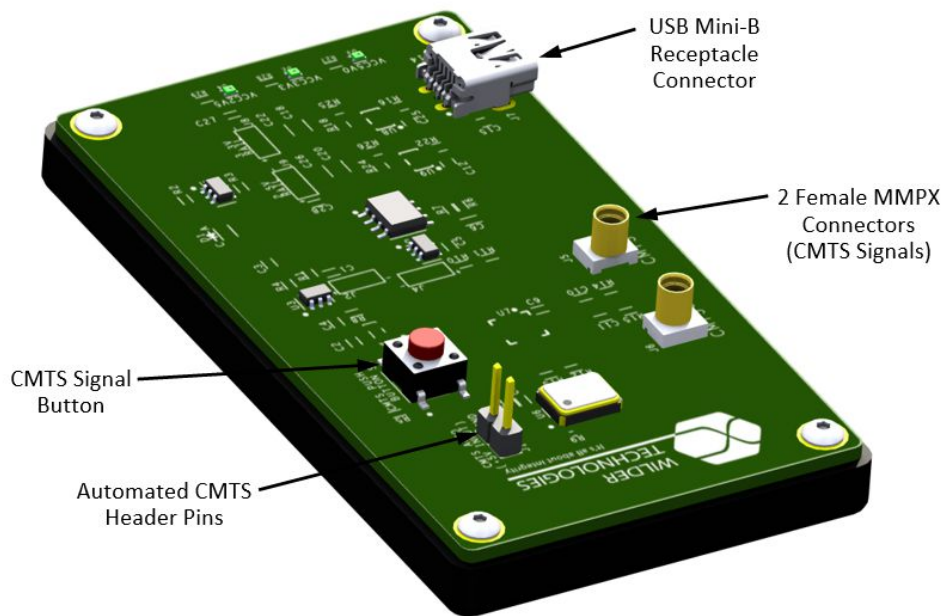

Figure 4. The PCIe Compliance Mode Toggle Signal (CMTS) Fixture

PCIe Gen-5 M.2 Socket-3 Test Adapters User Manual

The standalone CMTS (Compliance Mode Toggle Signal) board generates a 1 ms pulse with a frequency of 100 MHz to cycle through compliance presets. The CMTS board has the following features.



Figure 5. CMTS Pulse Duration (1 ms)



Figure 6. CMTS Frequency (100 MHz)

USB Mini-B connector to provide power to CMTS board.

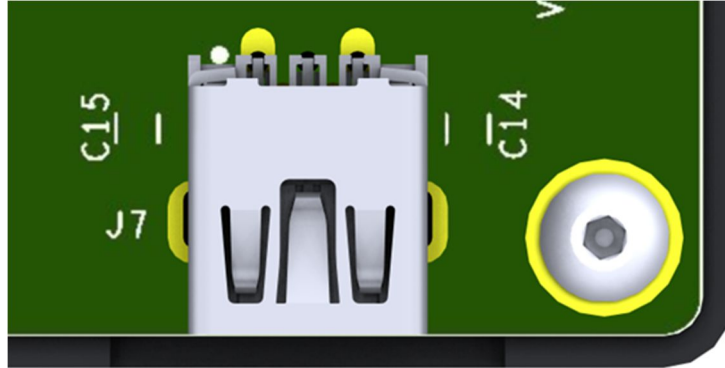

Figure 7. CMTS Board USB Mini-B Connector (J7)

Two MMPX connectors to output compliance mode toggle signal. These signals should be routed to the PER0 MMPX differential connectors of the CLB or CBB that the users DUT is connected to.

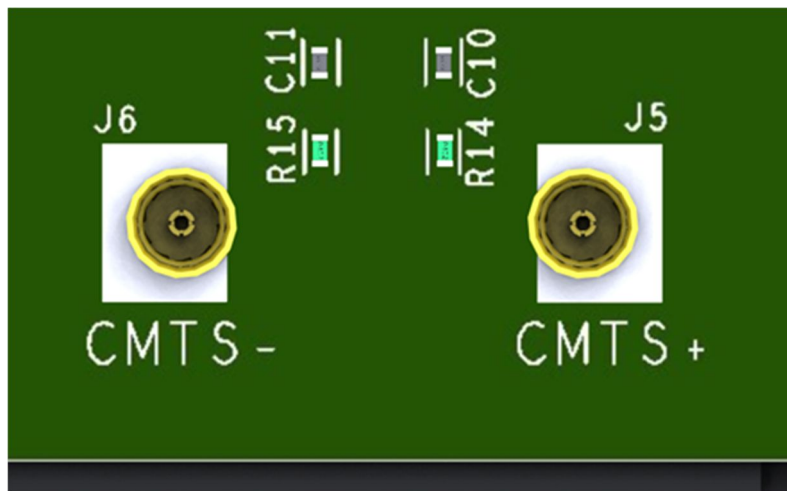

Figure 8. CMTS Differential Output SMP Connectors (J5 and J6)

CMTS push button. This button is used to generate the compliance mode toggle signal.

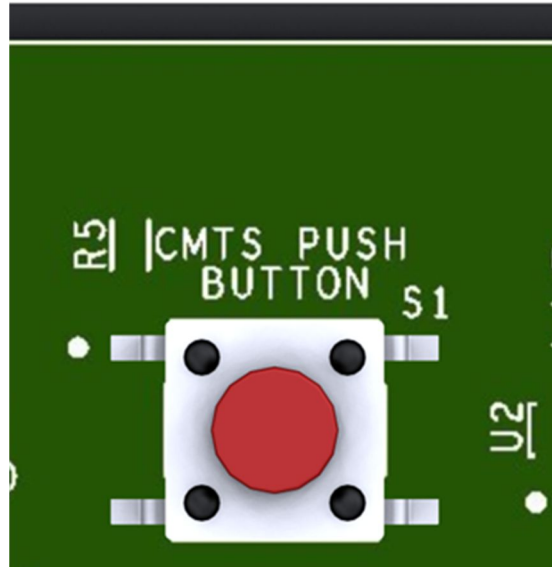

Figure 9. CMTS Push Button (S1)

The CMTS automation header shown below can be used as an alternative to the CMTS push button to generate the compliance mode toggle signal. This header can be connected to a user interface (such as a standard GPIO) to control the compliance mode toggle signal.

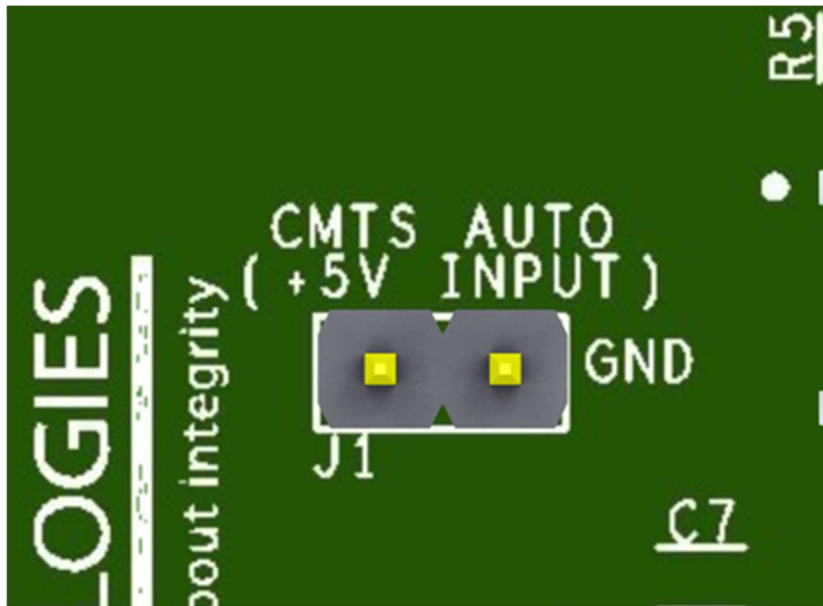

Figure 10. CMTS Automation Header (J1)

CBB Test Fixture Features

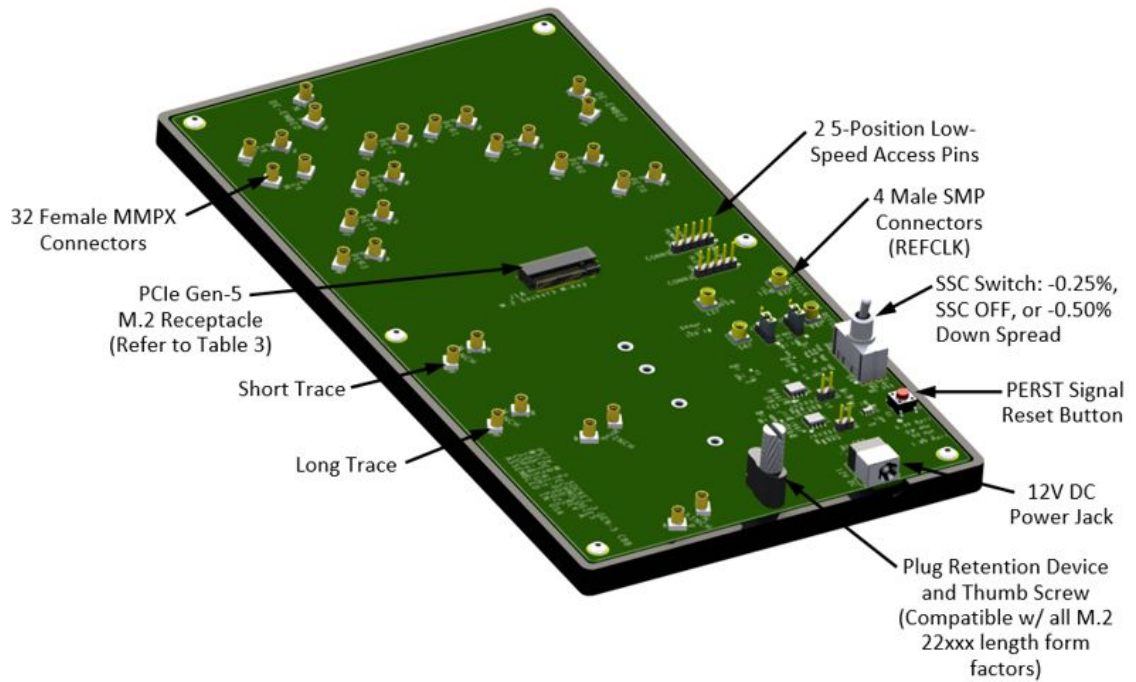

Figure 11. The PCIe Gen-5 M.2 Socket-3 Compliance Base Board (CBB)

- 12V DC Power Jack
 - The M.2 CBB uses a 12V DC power jack and is powered by a 12V DC power supply.

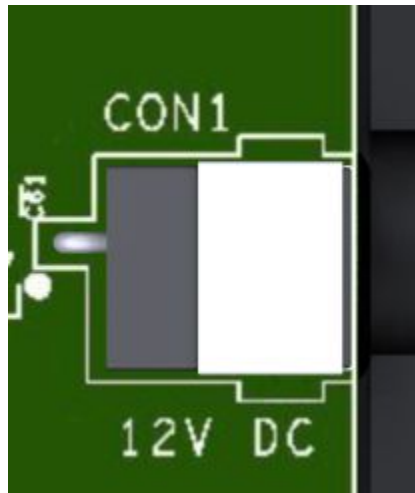

Figure 12. CBB 12V DC Power Connector (CON1)

- REFCLK/SSC
 - The M.2 CBB can provide a REFCLK with no SSC, or two SSC settings of 0.25% downspread or 0.5% downspread. This selection is made using the REFCLK SSC selection switch. With the switch placed in the middle position, the M.2 CBB will provide a 100 MHz REFCLK with no SSC. Placing the switch in the “SSC ON - 0.5%” position will enable 0.5% downspread SSC to the REFCLK and placing the switch in the “SSC ON - 0.25%” position will enable 0.25% downspread to the REFCLK. These SSC settings do not apply to an externally provided REFCLK and only to the REFCLK provided by the M.2 CBB fixture.



Figure 13. CBB REFCLK SSC Selection Switch (S4)

- REFCLK selection switch
 - The REFCLK allows the user to select between the REFCLK generated by the M.2 CBB or an externally provided REFCLK. When selecting an external REFCLK, this clock shall be provided to the M.2 CBB via the 2 “External REFCLK” SMP connectors.

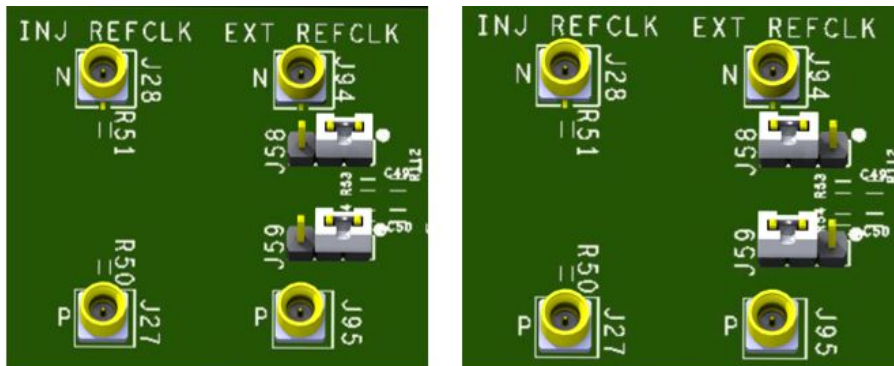

Figure 14. The internal REFCLK is selected (LEFT), the user provided REFCLK is selected (RIGHT).

- PERST

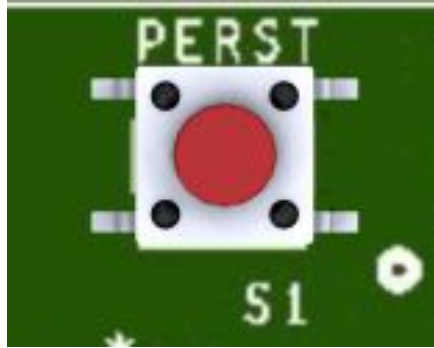

Figure 15. CBB PERST Push Button (S1)

- The M.2 CBB supports a PERST (PCIe Reset) signal. PERST is the primary reset signal used to reset the DUT. The PERST signal will be low while there is no power applied to the M.2 CBB. Upon power up, the PERST signals will automatically go high after a 100 ms delay from when the last power rail on the M.2 CBB goes high to ensure all power rails are stable before de-asserting reset.



Figure 16. Automatic PERST Signal Delay (100 ms)

Additionally, the PERST push buttons can be used to manually trigger a 100 ms PERST signal to reset the DUT.



Figure 17. Manual PERST Signal (100 ms)

- Sideband Signal Header Pins
 - The CBB has low speed header pins to connect to certain sideband signals from the device DUT.

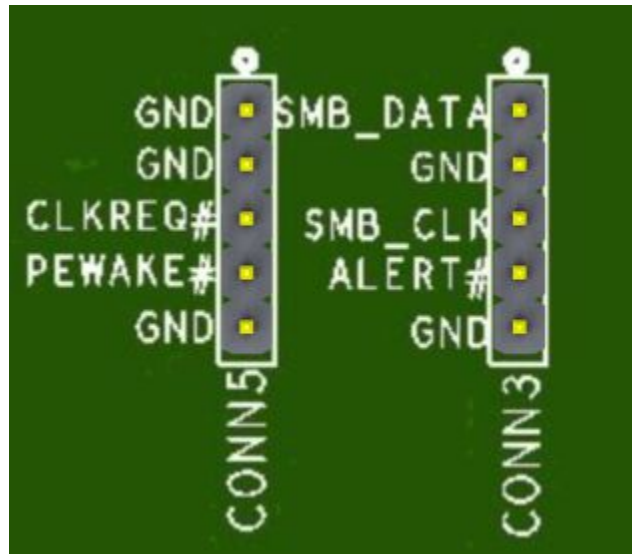

Figure 18. CBB Sideband Signal Header Pins (CONN5 and CONN3)

- Lane characterization
 - Lane characterization traces are included on both M.2 CLB and CBB fixtures. These characterization lanes include a short trace and long trace used to determine the loss per inch of the fixture being characterized. This is done by taking a through measurement of the short trace and a through measurement of the long trace. The difference in loss between the long and short trace divided by difference in length of the long trace and short trace will give the loss per inch of the fixture. The lengths of the long and short traces are listed below for the CLB and CBB fixtures:
 - Long Trace Length: 3.9"
 - Short Trace Length: 2.1"

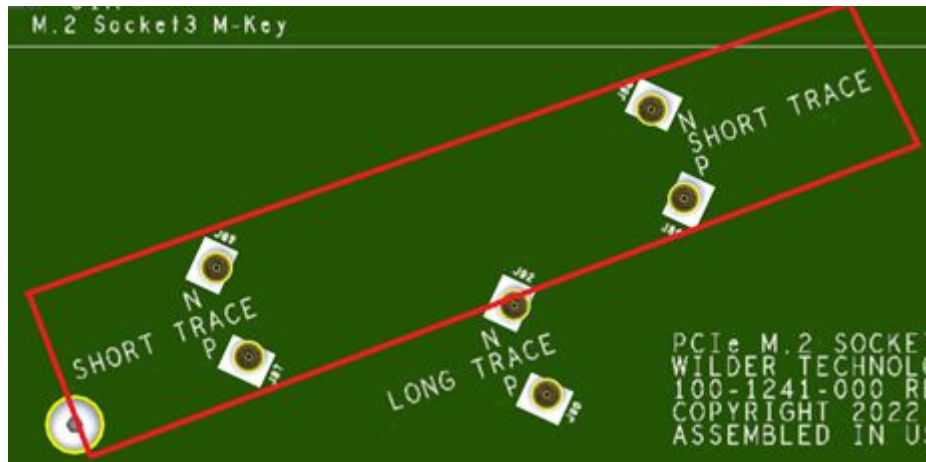

Figure 19. CBB Short Characterization Channel

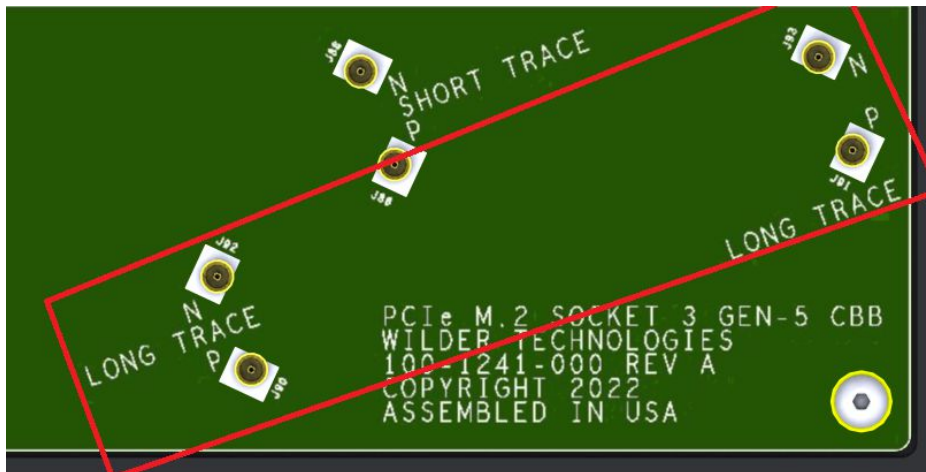

Figure 20. CBB Long Characterization Channel

- In addition to the short and long traces, the 2X through channel and de-embed channels can be used to characterize the specific traces on the CBB or CLB. The de-embed channel is a replica of the 3" TX and RX traces on the CBB plus half of the 2X through. Therefore, by de-embedding half of the 2X through channel

from the de-embed channel the TX and RX channels minus connector pads can be characterized.

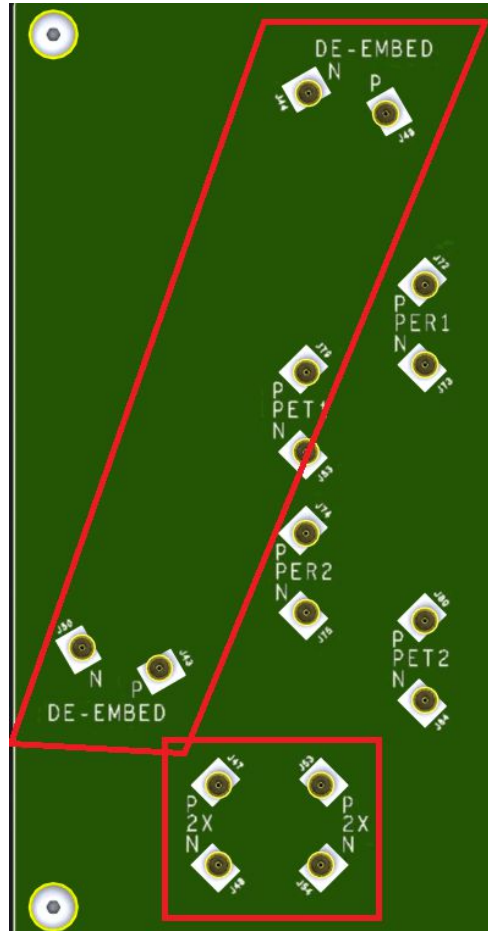

Figure 21. CBB 2X Thru and De-embed Channels

CLB Test Fixture Features

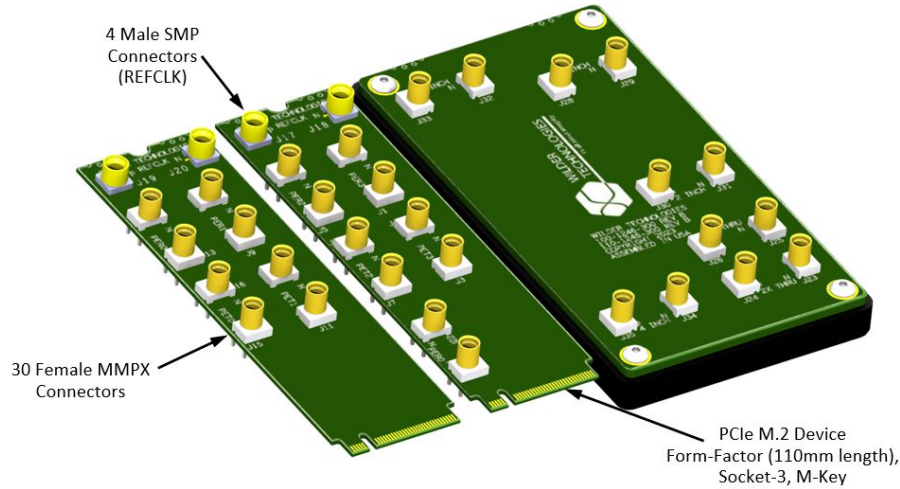

Figure 22. The PCIe Gen-5 M.2 Socket-3 Compliance Load Boards (Left to Right: RX0-1 and TX01 Channels, RX2-3 and TX2-3 Channels, and Replica Channels)

- Lane characterization
 - Similarly to the CBB, the CLB also has a 2X through trace, short trace, and long trace. However, the short and long trace also serve as the de-embed traces for the RX traces (long trace) and TX traces (short trace).
 - Long Trace Length: 4.4"
 - Short Trace Length: 2.4"

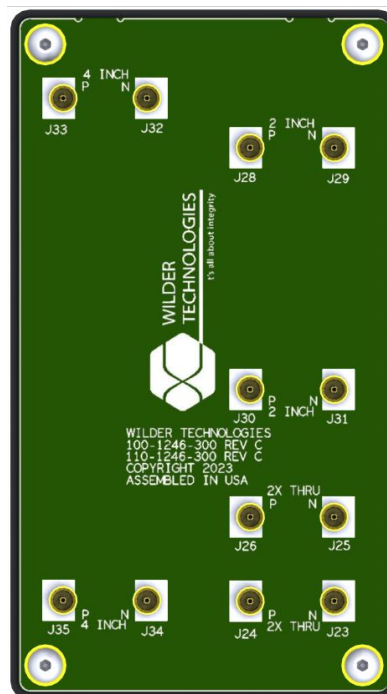

Figure 23. CLB Characterization Traces

- REFCLK SMP Connectors
 - The CLB has differential SMP connectors for probing the REFCLK on each of the CLB boards.

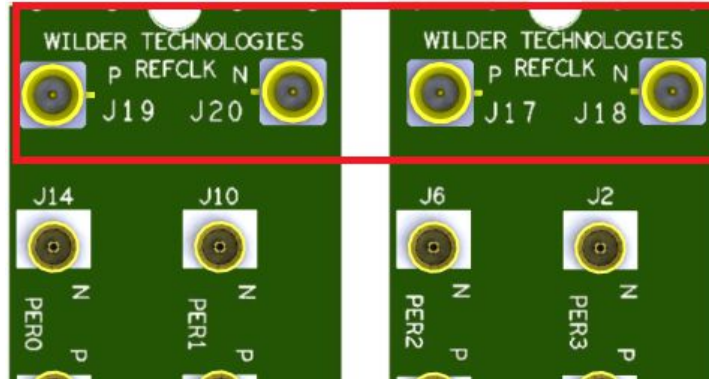

Figure 24. CLB REFCLK SMP Connectors

TX Testing User Models

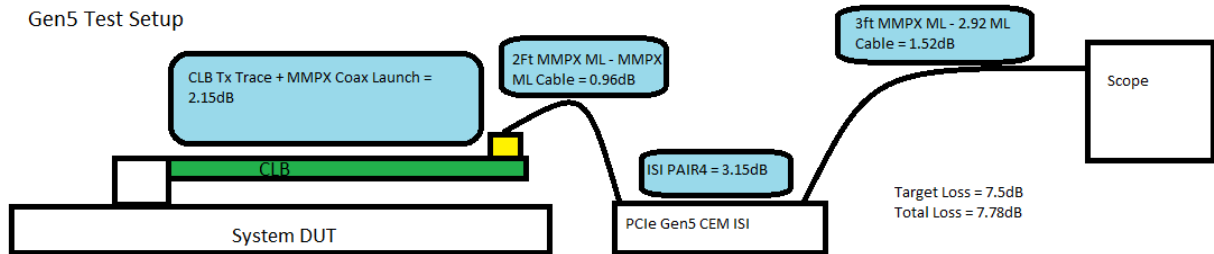

Figure 25. Total Test Channel Loss for Gen-5 Example

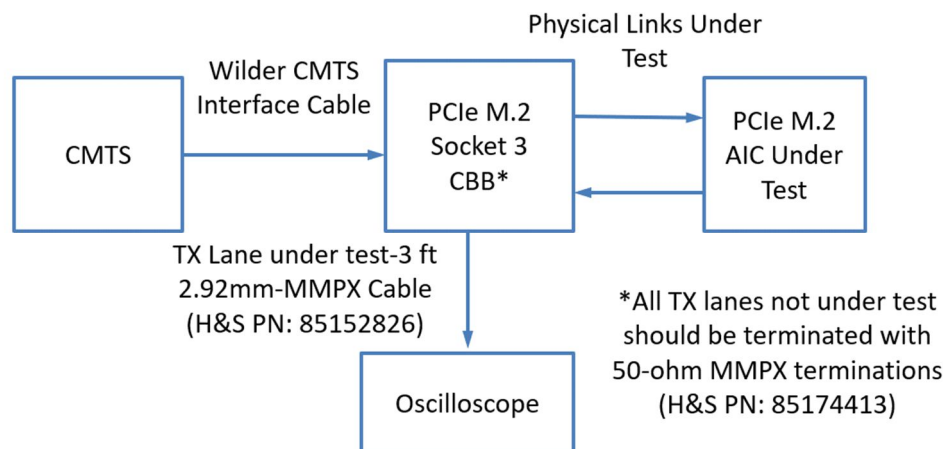

Figure 26. Add-in Card TX Test Setup Example

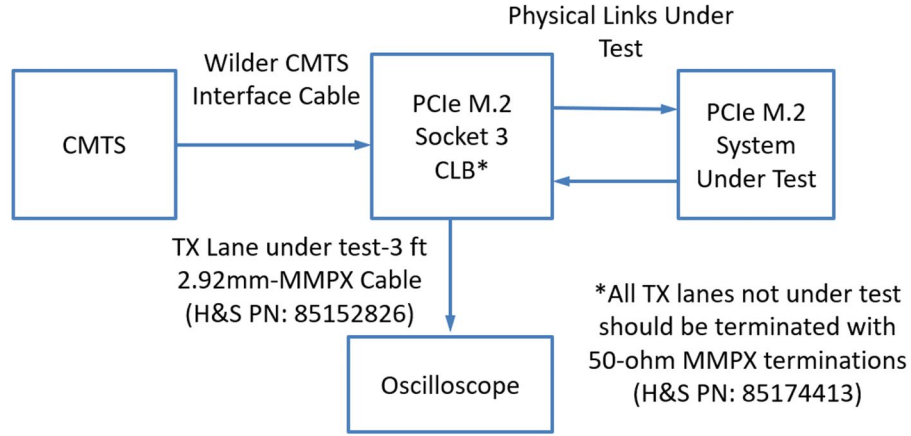

Figure 27. System Board TX Test Setup Example

RX Testing User Models

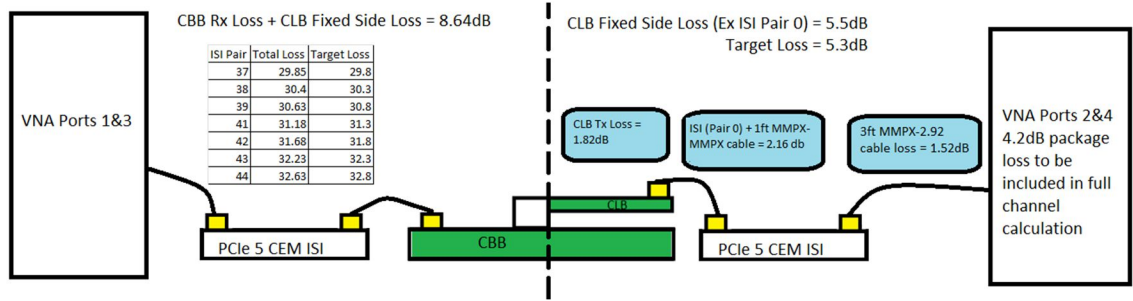

Figure 28. Add-In Card Calibration Example

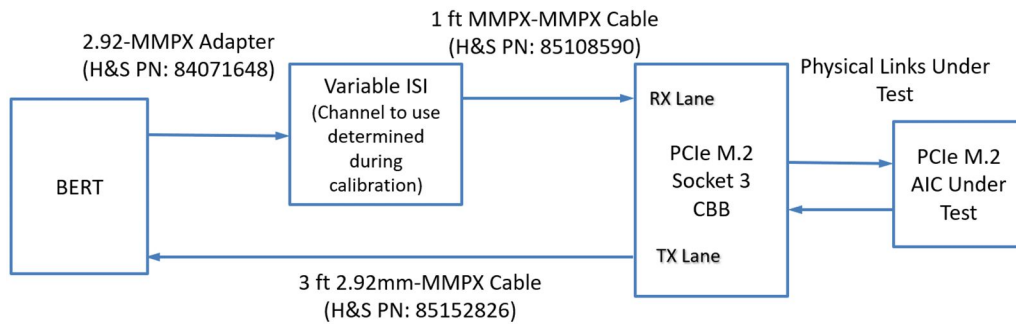

Figure 29. Add-In Card TX Test Setup Example

PCIe Gen-5 M.2 Socket-3 Test Adapters User Manual

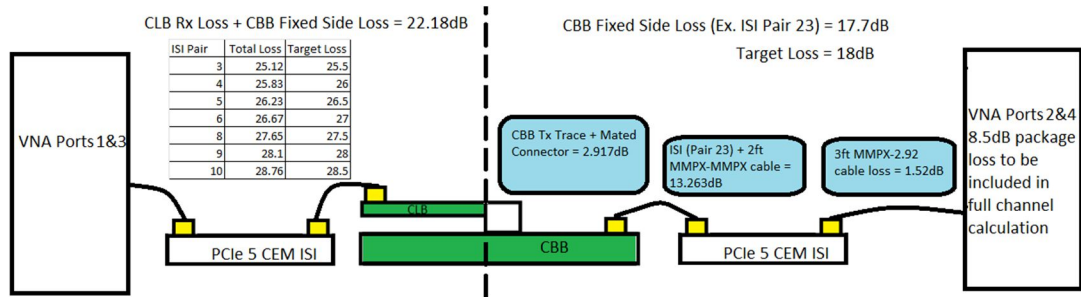

Figure 30. System RX Calibration Example

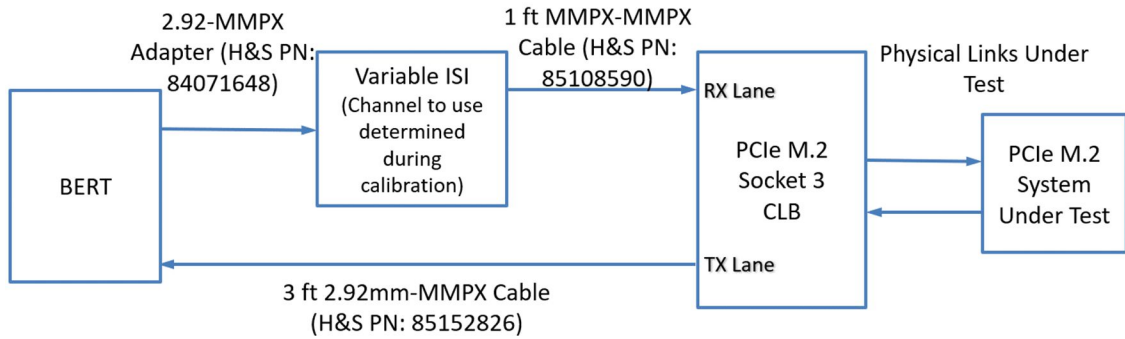

Figure 31. System RX Setup Example

110-1242-100 and 110-1242-200 (CLB) RF signal breakout summary

Only some of the Rx and Tx signals are broken out with RF connectors between the two CLBs (110-1246-100 and 110-1246-200). The other signals that are not broken out on the respective board are terminated on the PCB. These RF breakouts on the 110-1246-100 and 110-1246-200 boards are outlined in the tables below. PER0 is broken out on both CLBs to allow injection of CMTS into the DUT; however, the PER0 breakout on the 110-1246-200 board should only be used for CMTS. The PER0 channel on the 110-1246-100 board is suitable for both PER0 channel measurements as well as CMTS injection.

Table 3. PCIe Gen-5 M.2 Socket-3 Plug (CLB) 110-1246-100 Signal Break Out Summary

Differential Signal	Description
PET0	RF breakout, Unterminated
PER0	RF breakout, Unterminated (Used for CMTS input and PER0 channel measurements)
PET1	RF breakout, Unterminated
PER1	RF breakout, Unterminated
PET2	No RF break out, terminated on PCB
PER2	No RF break out, terminated on PCB
PET3	No RF break out, terminated on PCB
PER3	No RF break out, terminated on PCB

Table 4. PCIe Gen-5 M.2 Socket-3 Plug (CLB) 110-1246-200 Signal Break Out Summary

Differential Signal	Description
PET0	No RF break out, terminated on PCB
PER0	RF breakout, Unterminated (Used for CMTS input only)
PET1	No RF break out, terminated on PCB
PER1	No RF break out, terminated on PCB
PET2	RF breakout, Unterminated
PER2	RF breakout, Unterminated
PET3	RF breakout, Unterminated
PER3	RF breakout, Unterminated

Mechanical and Environmental Specifications

NOTE: All specifications in this manual are subject to change.

Table 5. General Specifications

ITEM	DESCRIPTION
Usage Environment	Controlled indoor environment
PCIEG5-M2-TPA3-CLB (Two Plugs) (L x W x H)	3.15" x 0.89" x 0.25" (80.0 mm x 22.6 mm x 6.4 mm)
PCIEG5-M2-TPA3-CLB (Replica Channel)	3.28" x 1.83" x 0.53" (83.3 mm x 46.5 mm x 13.5 mm)
PCIEG5-M2-TPA3-CBB	9.50" x 5.00" x 1.50" (243.8 mm x 127.0 mm x 38.1 mm)
PCIE-CMTS-TPA	3.28" x 1.83" x 0.64" (83.3 mm x 46.5 mm x 16.3 mm)
Operating Temperature	0°C to +55°C (32°F to +131°F) (Characteristic)
Storage Temperature	-40°C to +70°C (-40°F to +158°F) (Characteristic)

PCIe Gen-5 M.2 Socket-3 Test Adapters User Manual

Table 6. PCIe Gen-5 M.2 Socket-3 Receptacle (CBB) Pin Assignments

Pin Description	Connector Pin Number	AIC DUT Destination
Ground	1, 3, 9, 15, 21, 27, 32, 33, 38, 39, 45, 51, 57, 71, 75	GND
+3.3 Volts	2, 4, 12, 14, 16, 18, 70, 72, 74	3.3 V
No Connect	20, 24, 26, 28, 46, 48, 67	NC
PETn3 (PCIe TX Lane 3 Negative)	5	PETn3
PETp3 (PCIe TX Lane 3 Positive)	7	PETp3
PERn3 (PCIe RX Lane 3 Negative)	11	PERn3
PERp3 (PCIe RX Lane 3 Positive)	13	PERp3
PETn2 (PCIe TX Lane 2 Negative)	17	PETn2
PETp2 (PCIe TX Lane 2 Positive)	19	PETp2
PERn2 (PCIe RX Lane 2 Negative)	23	PERn2
PERp2 (PCIe RX Lane 2 Positive)	25	PERp2
PETn1 (PCIe TX Lane 1 Negative)	29	PETn1
PETp1 (PCIe TX Lane 1 Positive)	31	PETp1
PERn1 (PCIe RX Lane 1 Negative)	35	PERn1
PERp1 (PCIe RX Lane 1 Positive)	37	PERp1
PETn0 (PCIe TX Lane 0 Negative)	41	PETn0
PETp0 (PCIe TX Lane 0 Positive)	43	PETp0
PERn0 (PCIe RX Lane 0 Negative)	47	PERn0
PERp0 (PCIe RX Lane 0 Positive)	49	PERp0
PWRDIS (Power Disable)	6	NC
PLN# (Power Loss Notification)	8	NC
LED_1#	10	LED_1#
VIO_1.8V	22	NC
PLA_S3# (Power Loss Acknowledge)	30	NC
USB_D+ (USB Data Positive)	34	NC
USB_D- (USB Data Negative)	36	NC
SMB_CLK (SMBus Clock)	40	SMB_CLK
SMB_DATA (SMBus Data)	42	SMB_DATA
ALERT# (Alert Notification to initiator)	44	ALERT#
PERST# (PCIe Reset)	50	PERST#
CLKREQ# (Clock Request)	52	CLKRQ#
REFCLKN (Reference Clock Negative)	53	DEV RCLK-
PEWAKE# (PCIe Wake)	54	PWAKE#
REFCLKP (Reference Clock Positive)	55	DEV RCLK+
MFG_CLOCK (Vendor Specific / Mfg. Pin)	56	NC
MFG_DATA (Vendor Specific / Mfg. Pin)	58	NC
Key-M	Displaced pins: 59, 60, 61, 62, 63, 64, 65, 66	N/A
SUSCLK (Suspend Clock)	68	SUSCLK
PEDET (Interface Detect) -NC on CBB	69	PEDET
VIO_CFG	73	VIO_CFG

PCIe Gen-5 M.2 Socket-3 Test Adapters User Manual

Table 7. PCIe Gen-5 M.2 Socket-3 Plug (CLB) Pin Assignments

Pin Description	Connector Pin Number	System DUT Destination
Ground	1, 3, 9, 15, 21, 27, 32, 33, 38, 39, 45, 51, 57, 71, 75	GND
3.3 V (+3.3 Volts)	2, 4, 12, 14, 16, 18, 70, 72, 74	NC
No Connect	20, 24, 26, 28, 46, 48, 67	NC
PERn3 (PCIe RX Lane 3 Negative)	5	PERn3
PERp3 (PCIe RX Lane 3 Positive)	7	PERp3
PETn3 (PCIe TX Lane 3 Negative)	11	PETn3
PETp3 (PCIe TX Lane 3 Positive)	13	PETp3
PERn2 (PCIe RX Lane 2 Negative)	17	PERn2
PERp2 (PCIe RX Lane 2 Positive)	19	PERp2
PETn2 (PCIe TX Lane 2 Negative)	23	PETn2
PETp2 (PCIe TX Lane 2 Positive)	25	PETp2
PERn1 (PCIe RX Lane 1 Negative)	29	PERn1
PERp1 (PCIe RX Lane 1 Positive)	31	PERp1
PETn1 (PCIe TX Lane 1 Negative)	35	PETn1
PETp1 (PCIe TX Lane 1 Positive)	37	PETp1
PERn0 (PCIe RX Lane 0 Negative)	41	PERn0
PERp0 (PCIe RX Lane 0 Positive)	43	PERp0
PETn0 (PCIe TX Lane 0 Negative)	47	PETn0
PETp0 (PCIe TX Lane 0 Positive)	49	PETp0
PWRDIS (Power Disable)	6	NC
PLN# (Power Loss Notification)	8	NC
LED_1# (Grounded on CLB)	10	LED_1#
VIO_1.8V	22	NC
PLA_S3# (Power Loss Acknowledge)	30	NC
USB_D+ (USB Data Positive)	34	NC
USB_D- (USB Data Negative)	36	NC
SMB_CLK (SMBus Clock)	40	NC
SMB_DATA (SMBus Data)	42	NC
ALERT# (Alert Notification to initiator)	44	NC
PERST# (PCIe Reset)	50	NC
CLKREQ# (Clock Request)	52	NC
REFCLKN (Reference Clock Negative)	53	DEV RCLK-
PEWAKE# (PCIe Wake)	54	NC
REFCLKP (Reference Clock Positive)	55	DEV RCLK+
MFG_CLOCK (Vendor Specific / Mfg. Pin)	56	NC
MFG_DATA (Vendor Specific / Mfg. Pin)	58	NC
Key-M	Displaced pins: 59, 60, 61, 62, 63, 64, 65, 66	N/A
SUSCLK (Suspend Clock)	68	NC
PEDET (Interface Detect)	69	NC
VIO_CFG	73	VIO_CFG

Electrical Specifications

NOTE: All specifications in this manual are subject to change.

Table 8. Electrical Specifications

SPECIFICATION	TYPICAL	NOTES
Differential Impedance (ohms), 100 ps Rise Time	85 ± 5%	All Differential Pairs, CBB and CLB, excluding PCIe M.2 connector.
Differential Impedance (ohms), 100 ps Rise Time	100 ± 5%	REFCLK Differential Pairs, CBB and CLB, excluding PCIe M.2 connector.
Impedance (ohms), 100 ps Rise Time	42.5 ± 5%	All Single-Ended High-Speed Signals, CBB and CLB, excluding PCIe M.2 connector.
Impedance (ohms), 30 ps Rise Time	50 ± 7%	MMPX Connectors
NEXT (dB), at 16 GHz	-40	All Differential Pairs, single aggressor, with PCIe M.2 connector and terminations
Current Carrying (A)	2.5	+3.3V Power

Typical High-Speed Serial Characteristics

The high-speed serial measurements of the PCIe Gen-5 M.2 Test Adapters use a 4-port (50 Ω) VNA calibrated from 50 MHz to 40 GHz with 800 points. The measurements are in the form of S-parameters.

The S-parameter measurements are renormalized to 42.5 Ω ports instead of 50 Ω ports. This was done so that the port impedance and adapter impedance match.

In addition, 2.92 mm to MMPX adapters and MMPX connectors are included in the S-parameter measurements, but they are then gated out of the return loss due to their 50 Ω impedance.

Ultimately, this post-processing makes the S-parameters accurately represent the performance of the high-speed channels of only the M.2 adapters.

Characterization (CLB and CBB Independent Only)

To characterize the real high-speed channels of the adapters only (no connector), the replica channels must be used. These replica channels include MMPX connector lead-in for what would be the M.2 connector side of the high-speed channels. This MMPX connector lead-in that is part of the S-parameter measurement must then be de-embedded to represent the real high-speed channels.

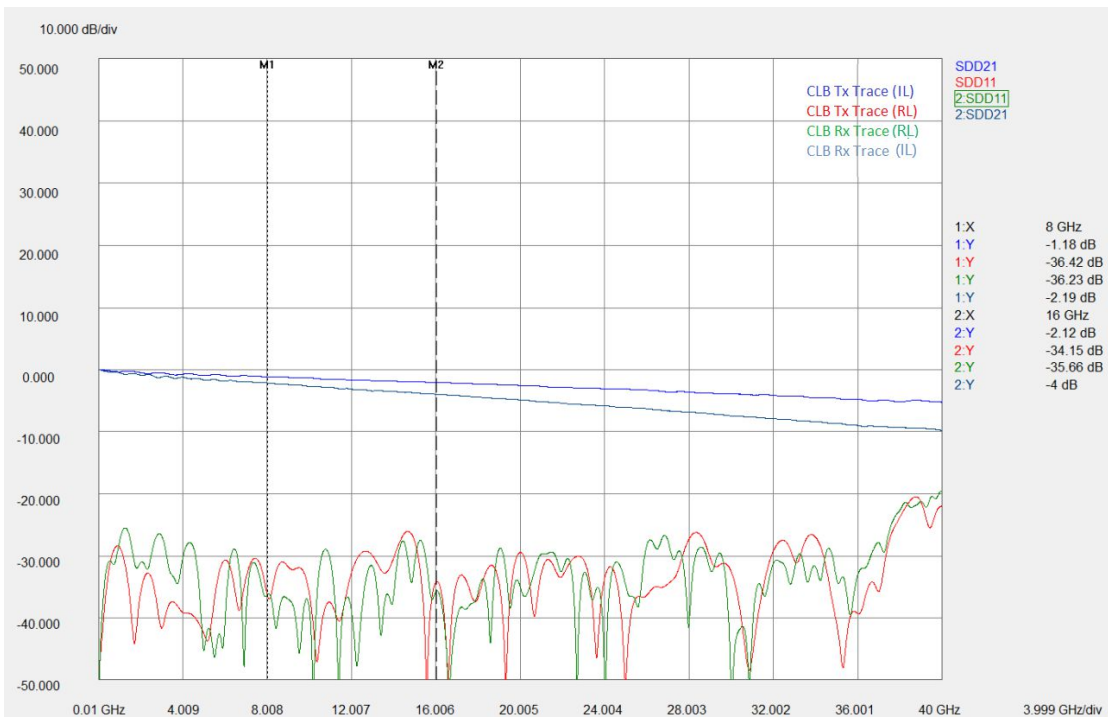

Figure 32. CLB (PCIEG5-M2-TPA3-CLB) characterization with renormalization and gating

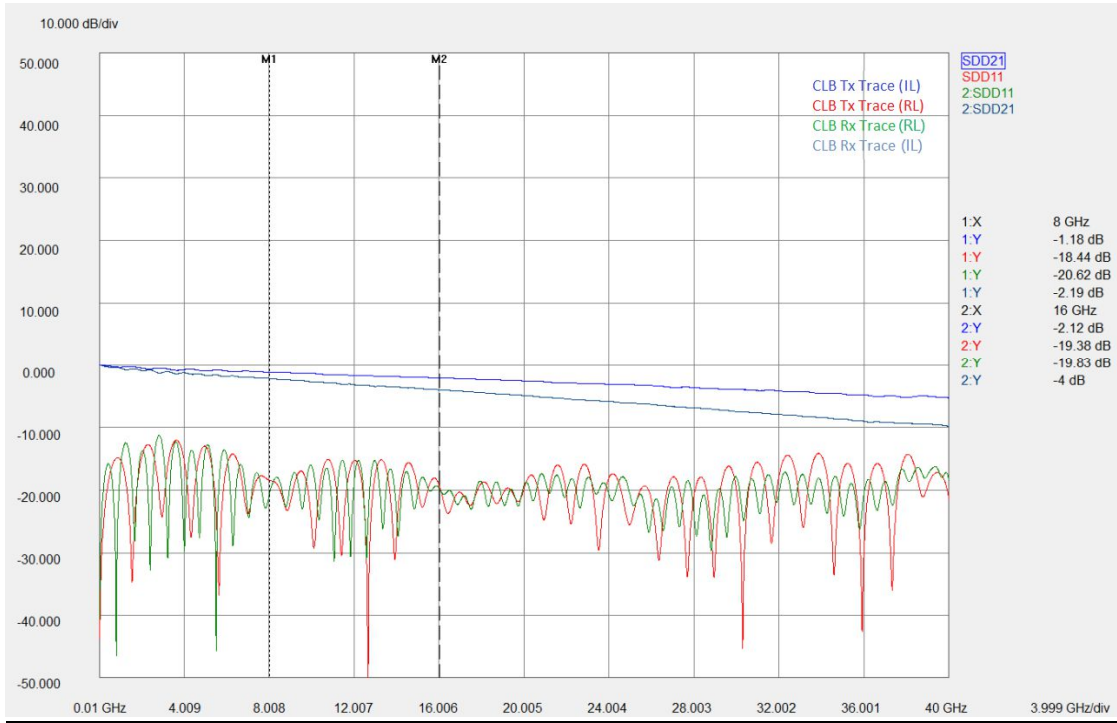

Figure 33. CLB (PCIEG5-M2-TPA3-CLB) characterization without renormalization or gating

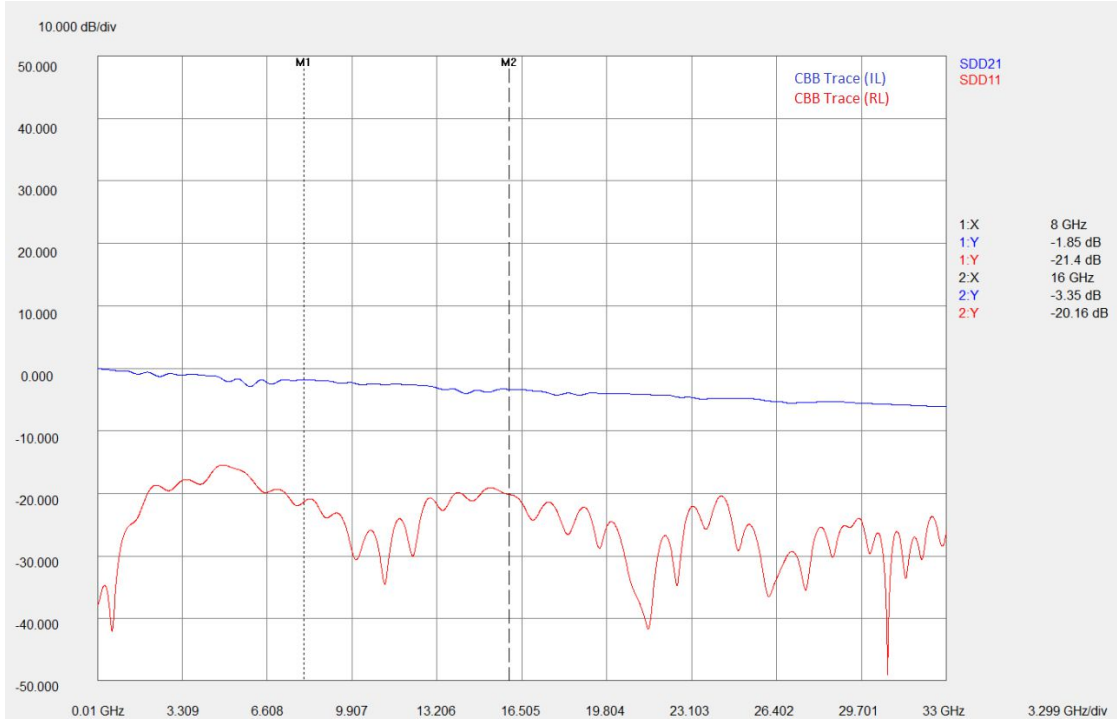

Figure 34. CBB (PCIEG5-M2-TPA3-CBB) characterization with renormalization and gating

PCIe Gen-5 M.2 Socket-3 Test Adapters User Manual

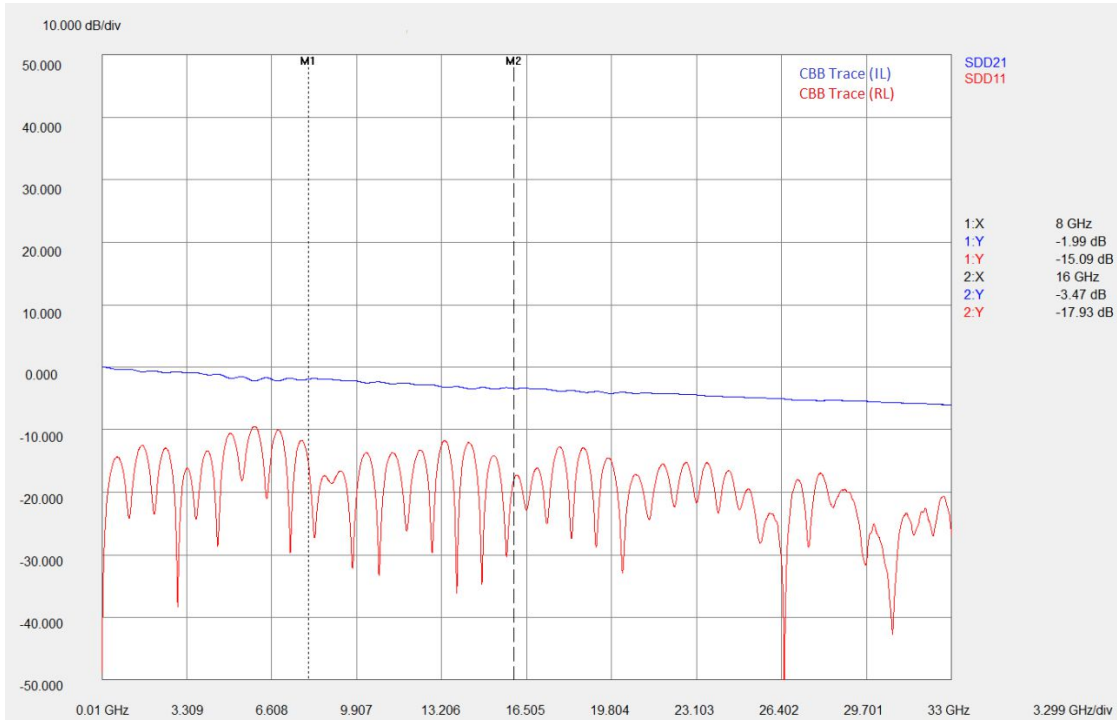

Figure 35. CBB (PCIEG5-M2-TPA3-CBB) characterization without renormalization or gating

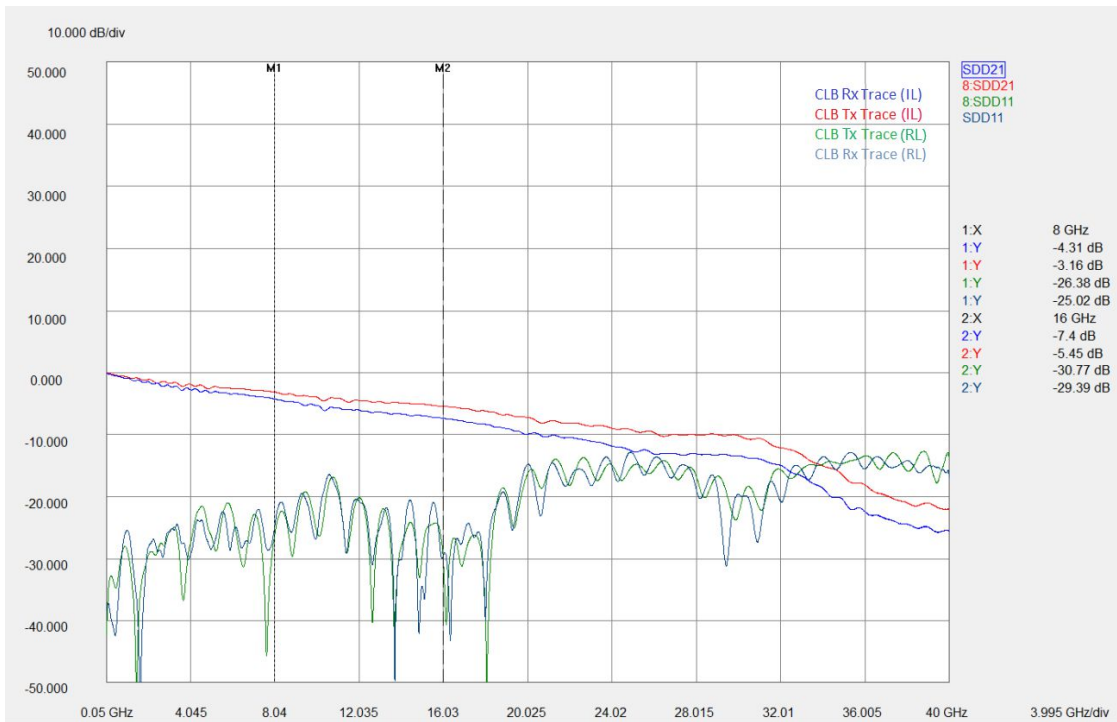

Figure 36. CLB and CBB (PCIEG5-M2-TPA3-CLBCBB) mated insertion and return loss with renormalization and gating

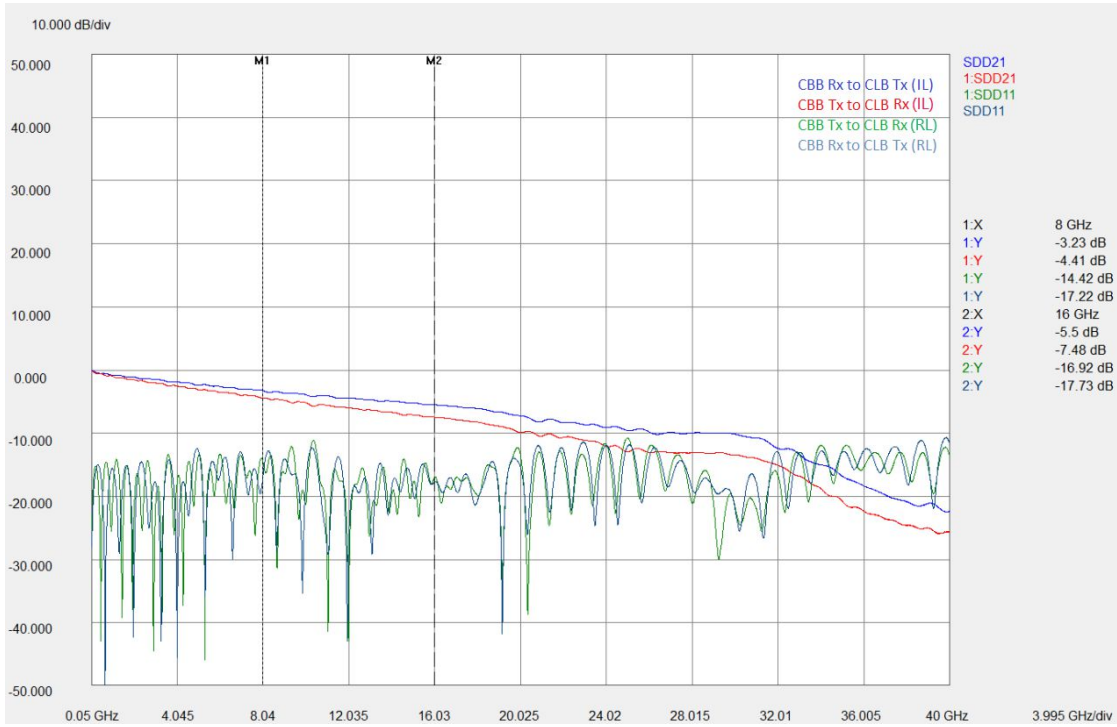

Figure 37. CLB and CBB (PCIEG5-M2-TPA3-CLBCBB) mated insertion and return loss without renormalization or gating

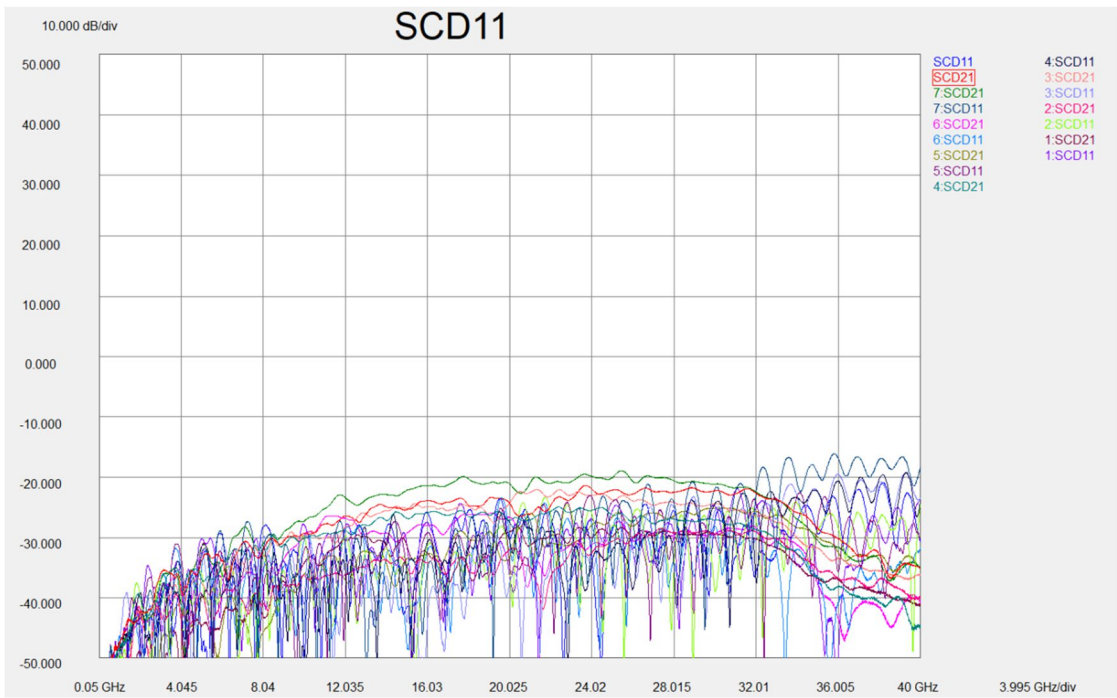

Figure 38. CLB and CBB (PCIEG5-M2-TPA3-CLBCBB) mated conversion loss

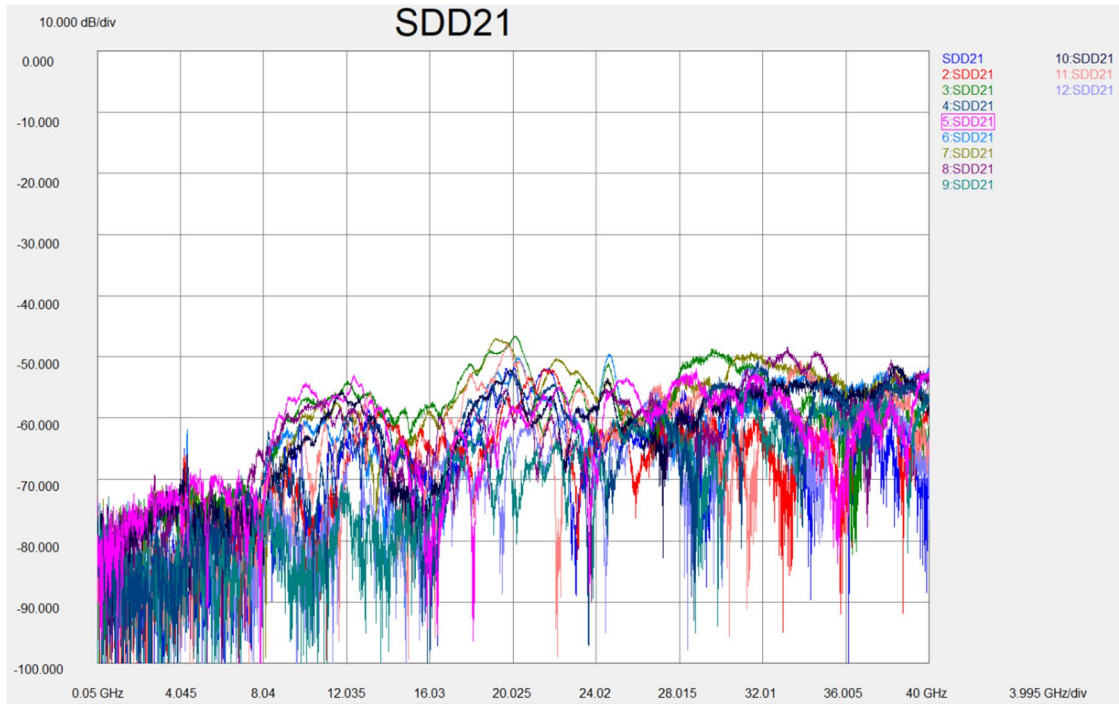

Figure 39. CLB and CBB (PCIEG5-M2-TPA3-CLBCBB) mated FEXT

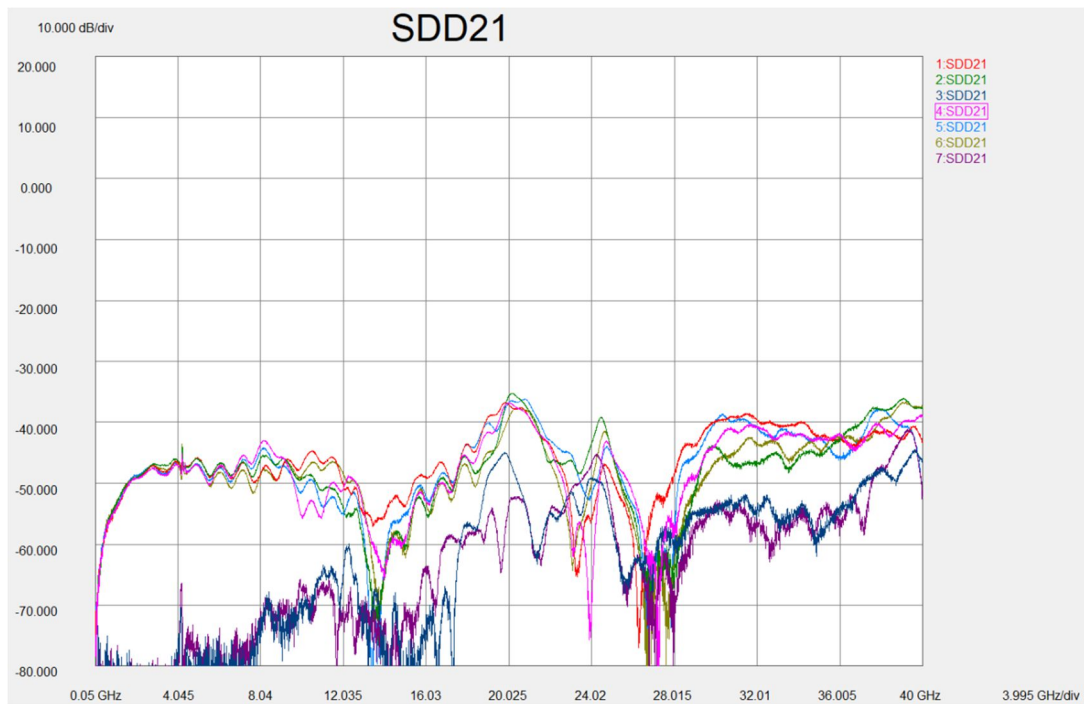

Figure 40. CLB and CBB (PCIEG5-M2-TPA3-CLBCBB) mated NEXT

Compliance with Environmental Legislation

Wilder Technologies, LLC, is dedicated to complying with the requirements of all applicable environmental legislation and regulations, including appropriate recycling and/or disposal of our products.



WEEE Compliance Statement

The European Union adopted Directive 2002/96/EC on Waste Electrical and Electronic Equipment (WEEE), with requirements that went into effect August 13, 2005. WEEE is intended to reduce the disposal of waste from electrical and electronic equipment by establishing guidelines for prevention, reuse, recycling and recovery.

Wilder Technologies has practices and processes in place to conform to the requirements in this important Directive.

In support of our environmental goals, effective January 1st, 2009 Wilder Technologies, LLC has partnered with EG Metals Inc. – Metal and Electronics Recycling of Hillsboro, Oregon, www.egmetalrecycling.com, to recycle our obsolete and electronic waste in accordance with the European Union Directive 2002/96/EC on waste electrical and electronic equipment ("WEEE Directive").

As a service to our customers, Wilder Technologies is also available for managing the proper recycling and/or disposal of all Wilder Technologies products that have reached the end of their useful life. For further information and return instructions, contact support@wilder-tech.com.



Compliance To RoHS 2 Substance Restrictions

Wilder Technologies, LLC certifies that the parts described in this document are compliant to the substance restrictions of Directive 2011/65/EU of the European Parliament, and of the Council of 8 June, 2011 on the restriction of the use of certain hazardous substances in electrical and electronic equipment (RoHS 2 Directive), prohibiting the use in homogeneous materials in excess of the listed maximum concentration value, except in cases where use is allowed by applicable exemptions listed in Annex III and Annex IV of the Directive.

Compliance with RoHS 2 has been verified through internal controls at design and production sites, including establishment of processes for specifying and controlling materials and segregation of non-compliant parts, receipt of supplier declarations of compliance and/or analytical test.

Glossary of Terms

TERMINOLOGY	DEFINITION
Add-in Card (AIC)	A card that is plugged into a connector and mounted in a chassis socket.
Aggressor	A signal imposed on a system (i.e., cable assembly) to measure response on other signal carriers.
CEM	Card Electromechanical
Decibel (dB)	Ten times the common logarithm (i.e. log10) of the ratio of relative powers.
Informative	The designation of a test that is not required for compliance but is considered important from a characterization standpoint. It is provided for informational purposes only.
Insertion loss	The ratio, expressed in dB, of incident power to delivered power.
Far-end crosstalk (FEXT)	Crosstalk that is propagated in a disturbed channel in the same direction as the propagation of a signal in the aggressor channel. The terminals of the aggressor channel and the victim channel are usually close to each other.
PCIe	Peripheral Component Interconnect Express
PCIEG5-M2-TPA3	PCIe Gen-5 M.2 Socket-3 Test Fixture. A specialized assembly that interfaces to an PCIe M.2 Socket-3 Receptacle or Plug and enables access of signals for measurement or stimulation.
M.2	Formally called Next Generation Form Factor (NGFF)
Near-end crosstalk (NEXT)	Crosstalk that is propagated in a disturbed channel in the opposite direction as the propagation of a signal in the aggressor channel. The terminals of the aggressor channel and the victim channel are usually close to each other.
Normative	The designation of a test that is required for compliance.
Return Loss	The ratio, expressed in dB, of incident power to reflected power.
RoHS	Restriction of Hazardous Substances Directive
USB	Universal Serial Bus
Victim	A signal carrier on a system that has a response imposed on it by other signals in the system.

Index

- 3.3V, 28
- Accessories and Optional Accessories, 4
- Add in Card (AIC), 36
- Cable Bend Limits, 7
- Cable Tension (Pull Forces), 7
- Cable Twisting (Torque), 7
- Care and Handling, 7
- Characterization (CLB and CBB Independent Only), 30
- Cleaning, 9
- Compliance
 - RoHS, 35
 - WEEE, 35
- DUT, 4, 28
- Electrical Specifications, 29
- Electrostatic Discharge Information (ESD), 10
- ESD protection, 10
- FEXT, 36
- Figures
 - Add-In Card RX Test User Model, 23
 - CBB Characterization, 31, 32
 - CLB Characterization, 30
 - Mated Conversion Loss, 33
 - Mated NEXT, 34
 - System Board TX Test User Model, 23
 - System RX Calibration User Model, 24
 - System RX Test User Model, 25
 - The PCIe M.2 Socket 3 Gen-5 Test Adapter Set, 3
- Glossary, 36
- Handling and Storage, 9
- Making Connections, 9
- Mechanical and Environmental Specifications, 26
- MMPX, 3, 4, 5, 9, 29, 30
- Module Insertion and Removal Instructions, 7, 8
- NEXT, 36
- PCIe Gen-5 M.2 Socket-3 Test Adapters, 3
- PCIe Specification, 11
- PCIE-CTMS-TPA, 4
- PCIEG5-M2-TPA3 Accessories, 4
- PCIEG5-M2-TPA3 Optional Accessories, 5
- Product Inspection, 6
- Product Return, 6
- Pull Force, 7
- RF Adapter, 5
- RoHS, 35, 36
- RX Testing User Models, 23
- Secure Storage, 6
- SMA, 5
- SMP, 5
- Supporting Instrument Cables or Accessories, 7
- Tables
 - Available Models, 3
 - Electrical Specifications, 29
 - General Specifications, 26
 - Optional PCIe Gen-5 Accessories, 5
 - PCIe Gen-5 M.2 Socket-3 CBB Pin Assignments, 27
 - PCIe Gen-5 M.2 Socket-3 CLB Pin Assignments, 25, 28
- Terminator Kit, 5
- TX Testing User Models, 21, 22
- Typical High-Speed Serial Characteristics, 30
- USB, 36
- User Models, 11
- Visual Inspection, 9
- Web Sites
 - support@wilder-tech.com, 35
 - www.egmetalrecycling.com, 35
- WEEE, 35

Visit our website at www.wilder-tech.com



**WILDER
TECHNOLOGIES**

It's all about integrity

Wilder Technologies, LLC
11201 NE 9th St.
Vancouver WA, 98684
Phone: 360-859-3041
Fax: 360-859-3105
www.wilder-tech.com

©2025 Wilder Technologies, LLC
Document No. 910-0077-000 Rev. E
Document Created: 4/11/2024